



G3200 Super Hybrid

*Installation and
Operations Manual*

**Copyright
Information** 

© Copyright 1997 Gentner Communications Corporation. All rights reserved. No part of this manual may be reproduced in any form or by any means without written permission from Gentner Communications Corporation. Printed in the United States of America. Original version, 10/93. Gentner Communications Corporation reserves specification privileges. Information in this manual is subject to change without notice.

G3200 Super Hybrid Installation and Operations Manual

Gentner Part No. 800-120-001 (Rev. 2.00)

January 1997

Manual Development: Bill Kilpack

Artwork and Illustrations: Jim Wright, Mike Greenhalgh

APPROVED for connection to
telecommunications systems specified
in the instructions for use subject to
the conditions set out in them.

 **504123**

The connection ports on the G3200 are to be used as follows:

| | |
|----------------|---|
| Power | Connection to the power cord provided |
| RS232 | Connection to external non-Gentner remote control |
| Remote Control | Connection to non-Gentner remote control |
| Speaker | Connection to external speaker(s) |
| Microphone | Connection to external microphone(s) |
| Send | Connection to send/program audio from console |
| Caller | Connection to processed caller audio from console |
| Mix | Connection to external recording device |
| Telephone Line | Connection to telephone line |
| Telephone Set | Connection to telephone set |
| Loop In | Connection to additional G3200 Loop Out (Audio) |
| Loop Out | Connection to additional G3200 Loop In (Audio) |

This equipment complies with the requirements of the EU guidelines:



89/336/EEC "Electromagnetic Compatibility"
73/23/EEC "Electrical operating material for use within specific voltage limits"

Conformity of the equipment with the above guidelines is attested by the CE mark.



Gentner Communications Corporation is committed to protecting the environment and preserving our natural resources.

This manual has been printed entirely on recycled paper.

Contents

| | |
|---|----|
| Introduction | 1 |
| Warranty Registration | 1 |
| Unpacking | 1 |
| Tools Required | 1 |
| Features and Benefits | 2 |
| Applications | 2 |
| Single Hybrid Use (Live Broadcast Applications) | 2 |
| Multiple Hybrid Interconnection (Caller Outputs Used) | 3 |
| Multiple Hybrid Interconnection (Caller Mix Used) | 3 |
| Meet-Me Teleconference Bridge | 4 |
| VIP Talk Shows | 4 |
| Looping G2500s and G3200s | 5 |
| Product Description | 5 |
| G3200 | 5 |
| Auto Mix-Minus | 5 |
| Front-Panel Controls | 5 |
| Back-Panel Connectors | 6 |
| Accessories | 7 |
| Before You Install | 8 |
| Acoustic Room Treatment | 8 |
| Power Requirements | 8 |
| Equipment Placement | 8 |
| Environmental Requirements | 8 |
| Telephone Set Option | 8 |
| PC Option | 8 |
| Installation | 9 |
| Completed Installation | 9 |
| Step 1 — Jumper Changes | 9 |
| Step 2 — Dip-Switch Changes | 10 |
| Step 3 — Rack Mounting | 11 |
| Step 4 — Back Panel Connections | 11 |
| Step 5 — Loop Connections | 12 |
| Calibration | 15 |
| Front Panel Controls | 15 |
| Step 1 — Trim Pot Levels | 15 |
| Step 2 — Caller Adjustment | 16 |
| Step 3 — Send Adjustment | 16 |
| Step 4 — Setup Routine | 17 |
| Operation | 18 |
| Answering a Call | 18 |
| Making a Call | 18 |
| Disconnecting a Call | 18 |
| Auto-Answer/Auto-Disconnect Mode | 18 |
| Mute Caller Audio | 19 |
| Remote Control Option | 19 |
| Recording Option | 19 |
| Performing an Analog Null | 19 |
| Emergency Restoration | 20 |
| When Not in Use | 21 |
| Specifications | 22 |
| Warranty | 23 |
| FCC Part 15 Compliance | 24 |
| FCC Part 68 Compliance | 24 |
| IC Compliance | 25 |

Contents continued

| | |
|--|----|
| Safety Information | 25 |
| BABT Recording Requirements | 26 |
| Appendix A: Connector Pinouts | 27 |
| Appendix B: Serial Port Commands | 28 |
| Appendix C: PC Command Quick Reference | 30 |
| Appendix D: G3200 Block Diagram | 31 |
| Appendix E: G3200 Schematics | 31 |

List of Figures

| | |
|--|----|
| Figure 1. Equipment diagram | 1 |
| Figure 2. Single G3200 application | 2 |
| Figure 3. Multiple G3200 application with caller audio mixed | 3 |
| Figure 4. Multiple G3200 application with separate caller audio | 3 |
| Figure 5. G3200 VIP application | 4 |
| Figure 5a. G3200 VIP application with jumper changes | 4 |
| Figure 6. Meet-me bridge G3200 application | 4 |
| Figure 7. G3200 front-panel controls | 6 |
| Figure 7a. G3200 front-panel controls | 6 |
| Figure 8. G3200 back-panel connectors | 7 |
| Figure 9. G3200 completed installation | 9 |
| Figure 10. G3200 jumper locations | 10 |
| Figure 11. G3200 back-panel connections | 11 |
| Figure 12. G3200 power module | 11 |
| Figure 13. G3200 RS232 connector | 11 |
| Figure 14. G3200 remote control DB15 connector | 11 |
| Figure 15. G3200 caller audio female XLR connector | 11 |
| Figure 16. G3200 male XLR caller connector | 11 |
| Figure 17. G3200 mix RCA jack | 11 |
| Figure 18. G3200 speaker connector | 11 |
| Figure 19. Microphone DB9 connector | 12 |
| Figure 20. RJ11C telephone-line connector | 12 |
| Figure 21. Multiple G3200 application with caller audio mixed | 12 |
| Figure 22. Multiple G3200 application with separate caller audio | 13 |
| Figure 23. G3200 VIP mode 1 | 13 |
| Figure 24. G3200 VIP mode 2 | 14 |
| Figure 25. G3200 Meet-me bridge | 14 |
| Figure 26. G3200 front-panel controls | 15 |
| Figure 27. G3200 trim-pot locations | 15 |
| Figure 28. Front-panel controls | 16 |
| Figure 29. G3200 trim-pot locations | 16 |
| Figure 30. Front-panel controls | 18 |
| Figure 31. G3200 jumper locations | 20 |
| Figure 32. G3200 power-up message | 28 |

List of Tables

| | |
|--|----|
| Table 1. Jumper Changes | 9 |
| Table 2. Dip-Switch Changes | 10 |
| Table 3. Remote Control DB15 Connector Pinouts | 27 |
| Table 4. RS232 DB9 Connector Pinouts | 27 |
| Table 5. Telephone Set and Line Connections | 27 |
| Table 6. DB9 Microphone Connector Pinouts | 27 |
| Table 7. G3200 Serial Port Commands | 28 |

Introduction ≡

Congratulations on purchasing Gentner's G3200 Super Hybrid. The latest in digital signal processing (DSP) technology has been incorporated into the G3200 for broadcast use.

This manual explains how to install, set up and operate your G3200. It also provides instructions on how to improve room acoustics and resolve minor technical problems, should any arise.

If you need information on how to install, set up or operate your system, please contact Gentner Communications Corporation at the location noted below. We welcome and encourage your comments so we can continue to improve our products and serve your particular needs.

Gentner Communications Corporation

1825 Research Way
Salt Lake City, Utah 84119

TEL: Worldwide (801) 975-7200 In U.S.A. (800) 945-7730
FAX: Worldwide (801) 977-0087 In U.S.A. (800) 933-5107
FAX-On-Demand 24-Hour Information Service (800) 695-8110
Worldwide Web Page @ <http://www.gentner.com>

Warranty Registration ≡

Please register your G3200 by completing the self-addressed, postage prepaid warranty registration card and return it to Gentner Communications by mail. You may also FAX it to the above listed fax number or call Gentner Communications. When your product is properly registered, Gentner Communications will be able to serve you better should you require technical assistance or desire to receive upgrades, new product information, etc.

Unpacking ≡

Ensure that the following equipment (See Figure 1, below.) was received with your shipment:

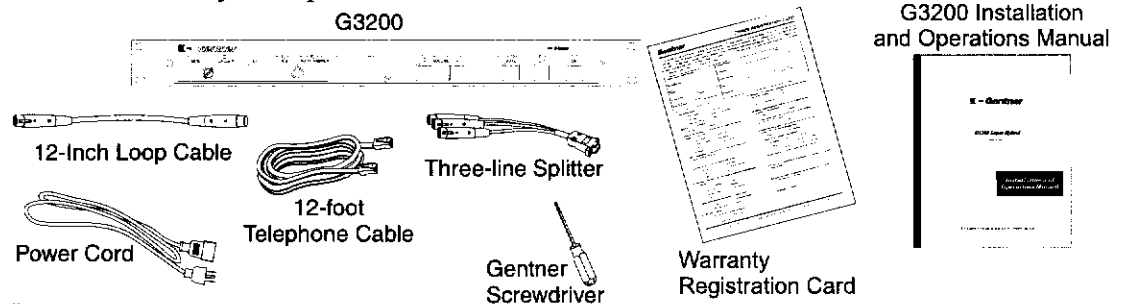

Figure 1. Equipment diagram

SHIPPING NOTE:

Gentner Communications is not responsible for product damage incurred during shipment. You must make claims directly with the carrier. Inspect your shipment carefully for obvious signs of damage. If the shipment appears damaged, retain the original boxes and packing material for inspection by the carrier. Contact your carrier immediately.

Tools Required ≡

- Gentner's small flat-blade screwdriver (for fine-tuning adjustment pots)
- Medium Phillips screwdriver (for rack mounting and opening chassis, if required)

Features and Benefits ≡

- Internally selectable auto mix-minus
- Superior echo cancellation and AGC (automatic gain control) routines for crisp, clear separation of send and receive audio
- 100-percent digital audio processing
- 224-millisecond echo cancellation span
- Nulling and rerull on new-line selection
- Easy to manage LED level-setting indicators
- Simple conference hookup with built-in loop conference bus
- Jumper selection separates callers when multiple hybrids are conferenced through the loop bus
- Built-in 3W power amp and three-channel mic mixer
- Auto-answer/auto-disconnect
- Volume-level control
- RS232 serial port available for remote control
- Highly reliable operation and setup integrity

Applications ≡

Gentner manufactures two super hybrid models: the G2500 for radio station and professional audio applications, and the G3200, primarily used when open microphones and speakers are connected to the hybrid. G3200s and G3200s can be looped together with good results when configured properly. For further G3200 information, consult the G3200 Installation and Operations Manual for complete information, or contact Gentner for technical assistance.

Single Hybrid Use (Live Broadcast Applications)

Thanks to the G3200's dual-operation configuration, the G3200 can be used in automatic mix-minus mode *or* as an acoustic echo canceller. When using automatic mix-minus, a single G3200 (See Figure 2, below.) permits program output to be fed down standard telephone lines, even when the output contains caller audio (the G3200 automatically removes the caller audio from its feed path). If your console provides its own auto mix-minus, the G3200's mix-minus can be easily disabled (by switching dip switch 1 OFF). When used as an acoustic echo canceller, the G3200's built-in microphone mixer and power amplifier allows up to three microphones and a

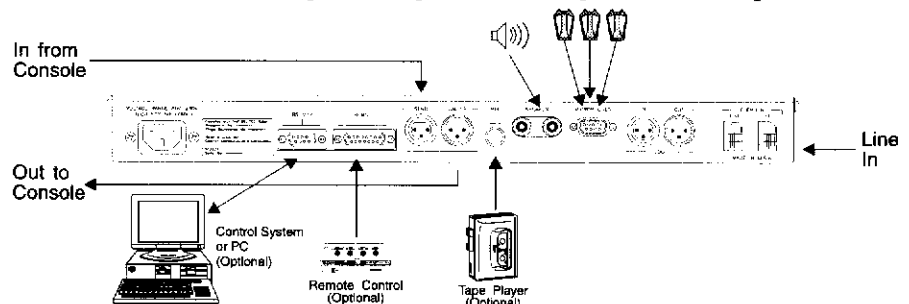

Figure 2. Single G3200 application

speaker to be connected directly, so the caller to be heard by the audience over the speaker while providing superior AEC without feedbacks.

Multiple Hybrid Interconnection (Caller Mix Used)

Up to eight G3200s can be used in sequence and looped together (See Figure 3, below.), while still maintaining high quality noise reduction and echo cancellation. In this application, all callers are mixed together and only one input is used on the console.

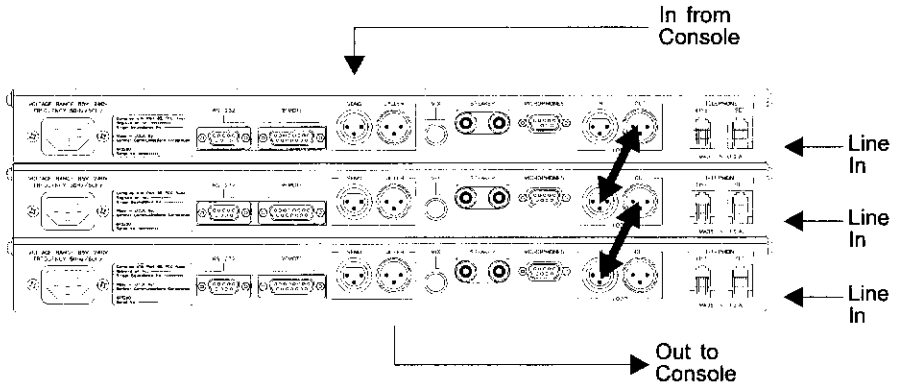

Figure 3. Multiple G3200 application with caller audio mixed

This conference mode is used when limited connections are available on the console. Internal AGC keeps all the callers at a consistent level. The G3200s are connected together by the LOOP IN/OUT XLR connectors.

Multiple Hybrid Interconnection (Individual Caller Outputs Used)

In this mode, up to eight G3200s can be linked in sequence (See Figure 4, below.); however, each hybrid is connected directly to its own pot on the console.

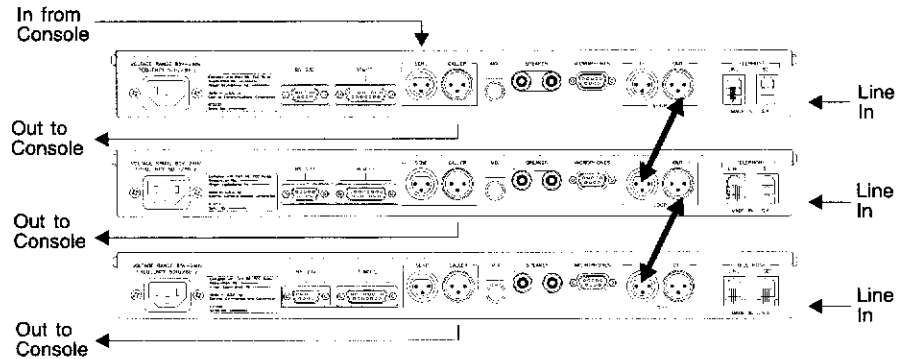

Figure 4. Multiple G3200 application with separate caller audio

Each individual call's volume can be adjusted from the console. The G3200s are connected together by the LOOP IN/OUT XLR connectors.

Applications
Continued ≡

VIP Talk Shows

Depending on the type of show format you use, your G3200s can be set up so caller audio can be either mixed or separated (Figure 5 and 5a, below).

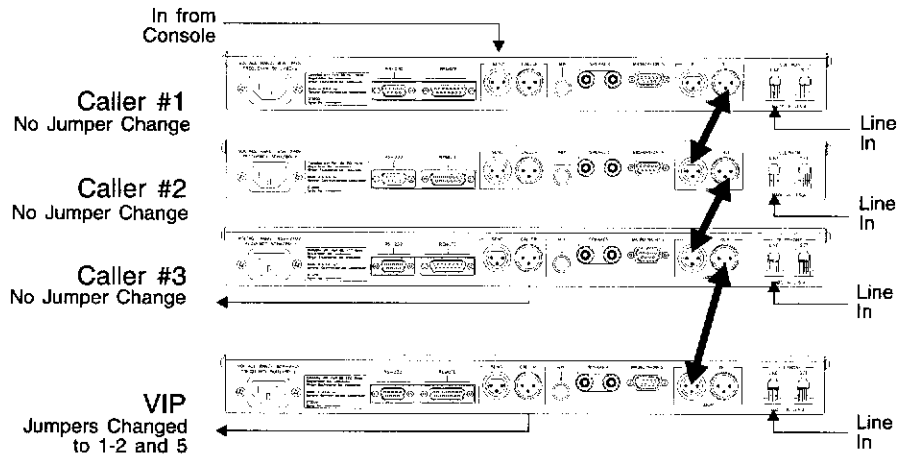

Figure 5. G3200 VIP application

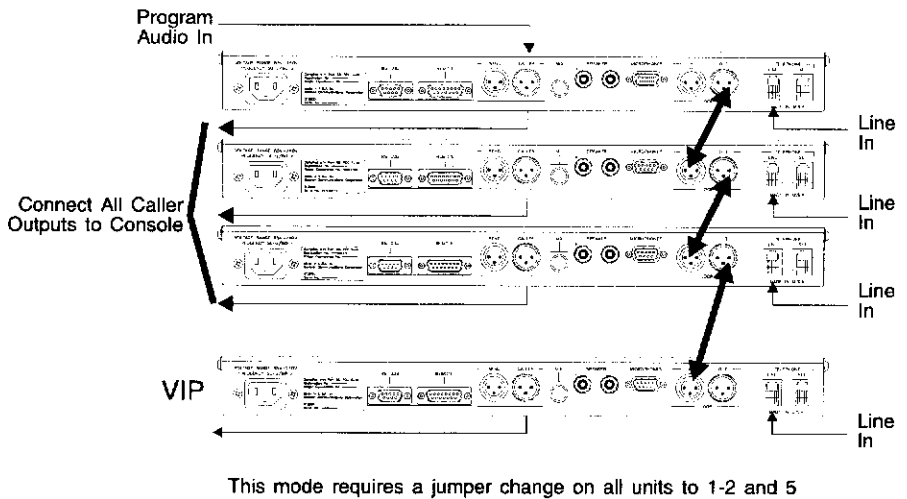
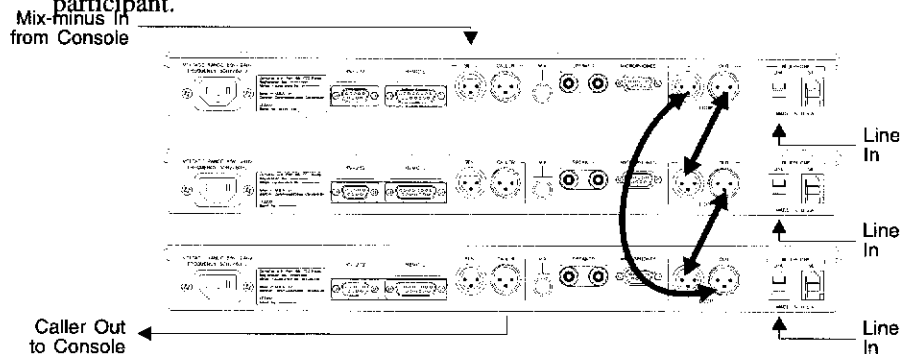

Figure 5a. G3200 VIP application with jumper changes

Your VIP and your audience will hear the cleanest telephone audio available.

Meet-Me Teleconference Bridge

Up to eight people can be conferenced together when each G3200 is connected to an incoming telephone line (See Figure 6, below.) and set up in auto-answer mode. In this application, each line's number is assigned to a participant.



This mode requires a jumper change on the last unit only to 3-4 and 6.

Figure 6. Meet-me bridge G3200 application

When the call is auto-answered, the caller is automatically linked to the others who have called in. The hybrids are interconnected through the LOOP IN/OUT connector. The G3200s sense loop drop and automatically disconnect each line when the caller hangs up.

Looping G2500s and G3200s

G2500s and G3200s can be looped together with good results if configured properly. When combining both models, the G3200 must not have open speakers and microphones, and an internal dip switch *must* be changed (See Installation, Page 9.) to provide the proper operating sequence.

Product Description

G3200

The G3200 operates with a 3.4kHz bandwidth and a 224-millisecond echo-cancellation span. It is designed for use in the television-studio environment where telephone-caller audio is introduced, as well as sound contracting applications where high quality, reliable, professional audio equipment is needed.

Auto Mix-Minus

No mix-minus is required from your console when the G3200 is configured for auto mix-minus operation; the G3200 generates its own mix-minus using AEC and AES routines to separate the caller audio out of the program feed (auto mix-minus on/off is selectable from the front panel). However, if the G3200 is being used as an echo canceller (dip switch 1 OFF), external mix-minus must be supplied.

Front-Panel Controls

G3200 front-panel controls and LED indicators make operation, control and adjustment simple (Figure 7, below). The front panel is numbered for easy identification.

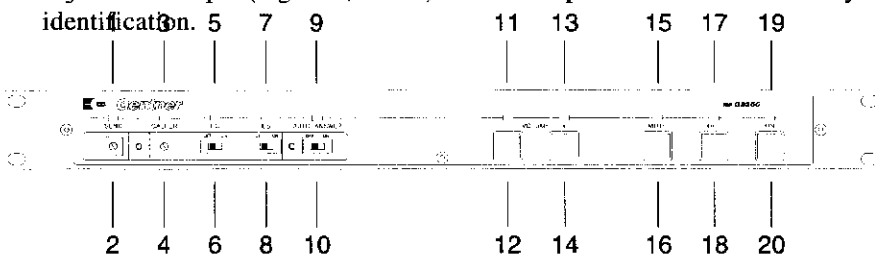

Figure 7. G3200 front-panel controls

1. *Send* LED. This red/green LED indicates send audio passing into the hybrid: green is normal level, red is peak level.
2. *Send*. This trim pot's nominal level is +4dBm (at 12 o'clock indicator notch). It controls send audio passing into the hybrid. Gain adjustment range from nominal is $-\infty$ to +12dB.
3. *Caller* LED. This red/green LED indicates caller audio passing into the hybrid: green is normal level, red is peak level.
4. *Caller*. This trim pot's nominal level is +4dBm (at 12 o'clock indicator notch). The trim pot controls caller audio into the hybrid. Gain adjustment range from nominal is $-\infty$ to +12dB.
5. *EC (Echo Cancellation)* LED. This red/green LED indicates ON/OFF status (either auto mix-minus or acoustic echo cancellation, depending on

Product Description**Continued** ≡

active mode); green is on and operating normally; red is when EC is in overload. (ES should be activated.) When the switch is OFF, the LED will be off.

6. *EC*. This latching switch is a dual-purpose ON/OFF switch (Figure 7a, below). For normal operation (either auto mix-minus or acoustic echo

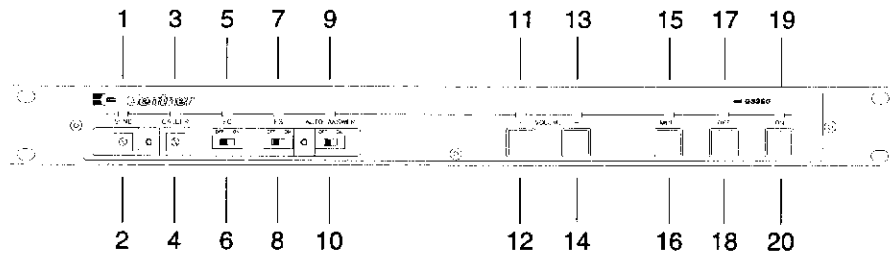

Figure 7a. G3200 front-panel controls

canceller), the EC switch should be ON (LED will be lit).

7. *ES (Echo Suppression) LED*. This red/green LED indicates ES status: green is when on and operating normally. When ES switch is OFF, the LED will not light.

8. *ES*. This latching switch should be turned ON when EC is in overload. When the ES switch is ON, the ES routine will be active and the LED will be lit green.

9. *Auto-Answer LED*. This green LED will be lit when the AUTO-ANSWER switch is ON, allowing auto-answer and auto-disconnect of incoming calls. The LED will not light when the function is inactive.

10. *Auto-Answer*. This latching switch activates the auto-answer/auto-disconnect mode. When inactive, hybrid answering must be performed manually.

11. *Volume - LED*. This green LED flashes rapidly when the VOLUME - button [12] is pushed. The LED glows solid green when volume reaches minimum level. The LED flashes once when the volume is reset to nominal level.

12. *Volume -*. This button reduces volume levels when it is pushed and held down. When a desired volume level is achieved (range 0–6dB), release the button.

13. *Volume + LED*. This green LED flashes rapidly when the VOLUME + button [14] is pushed. The LED glows solid green when volume reaches maximum level. The LED flashes once when the volume is reset to nominal level.

14. *Volume +*. This button increases volume levels when it is pushed and held down. When a desired volume level is achieved (range 0–6dB), release the button.

15. *Mute LED*. This red LED indicates mute activity. When lit, mute is active. No light indicates mute mode is off.

16. *Mute*. This momentary latching button turns the mute mode on/off. When ON, *only* caller audio is muted.

17. *On LED*. This green indicator LED glows only when the system is ON.

18. *On*. This momentary latching button turns the G3200 ON, allowing caller audio to be processed and sent to the console.

19. *Off LED*. This red LED glows only when the hybrid is ON.

20. *Off*. This momentary latching button turns the hybrid OFF, terminating all processing and audio signals.

Back-Panel Connectors

1. *Power*. This auto-adjusting power module will accommodate voltage requirements between 85–240Vac, 50/60Hz (Figure 8, next page, top).

Figure 8. G3200 back-panel connectors

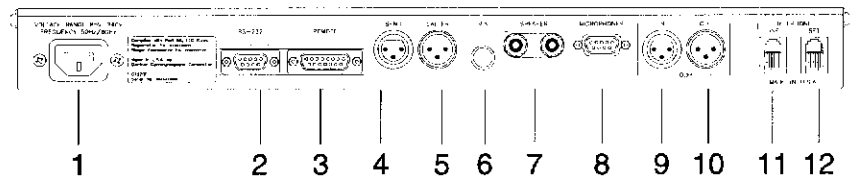

2. *RS232*. This DB9 female connector is a serial port used to control the G3200 front-panel functions from a PC.
3. *Remote*. This female DB15 connector is used with a customer-supplied remote control to access front-panel functions (i.e. ON, OFF and MUTE).
4. *Send*. This female XLR connector is used to input balanced program audio from the console into the hybrid.
5. *Caller*. The male XLR connector provides balanced caller output audio to the console.
6. *Mix*. This RCA connector contains both program and caller audio. This jack is used to connect to your recording device.
7. *Speaker*. These dual, five-way binding posts are designed for connection of a single 4ohm speaker.
8. *Mic*. This DB9 connector allows for up to three microphones to be connected. The audio is mixed with the main send audio.
9. *Loop In*. This female XLR connector bridges conferencing input between multiple hybrids.

LOOP-IN/LOOP-OUT NOTE:

The loop feature allows you to connect multiple G3200s together to enable quick setup in a variety of operating modes, while still maintaining audio quality. See Applications, Page 2. The LOOP IN connector [9] can only be used in conjunction with the LOOP OUT connector [10] (conference bus), and vice versa (see below).

10. *Loop Out*. This male XLR connector bridges conferencing output between multiple G3200s.
11. *Line*. This standard RJ11C telephone jack connects your telephone line to the G3200.
12. *Set*. This telephone set jack connects your telephone set to the hybrid via the RJ11C connector.

Accessories

A user-supplied remote control or contact-closure controller can be connected to the REMOTE DB15 connector [3] to activate front-panel functions (optional).

**Before You
Install** 

The G3200 is designed to work in almost any acoustic environment. To maximize your audio quality, we recommend that you prepare your teleconferencing site by taking the following factors into consideration:

Acoustic Room Treatment

Conference room treatment is recommended to improve the operation of your teleconferencing system. Rooms that have large areas of windows, white boards, hard floors, etc., are acoustically "live." These areas increase the amount of audio reverberation in the room which, in turn, reduces the audio quality of your teleconference. You should minimize the amount of audio reverberation where possible.

You can improve room acoustics by installing acoustic panels, drapes and other wall fabrics. Another way to improve overall room acoustics is to keep room noise (i.e. computers and fans) to a minimum.

Power Requirements

The G3200 automatically accommodates voltage requirements ranging from 85–240Vac, 50/60Hz power. No switching is required.

Equipment Placement

The G3200 is designed for mounting in a 19" equipment rack.

Environmental Requirements

The G3200 can be safely operated in a room with varying temperatures between 32° and 100° F, and relative humidity from 0–80 percent.

Telephone Set Option

A single-line telephone set is not required for normal use; however, the SET jack is provided should you need to connect a telephone set (analog with DC on the audio pair recommended) to your G3200. Your G3200 functions with standard analog telephone lines and connects to the telephone system with a standard RJ11C modular jack. If you do not have an RJ11C jack where you want to install your G3200, call your telephone company for installation.

If you are connecting your G3200 to a private branch exchange (PBX) system, contact your telephone equipment manufacturer or service representative. Some PBX systems will not work with your G3200.

PC Option

A user-supplied PC can be linked to the G3200 through the RS232 serial port to operate front-panel functions.

Installation 

The G3200 was designed for easy installation and setup. All necessary interface connections are made through rear-panel connectors. This allows for easy installation, removal and service. To install your G2500, follow these step-by-step instructions:

Completed Installation

The following block diagram (See Figure 9, below.) shows a G3200 system when installation is complete.

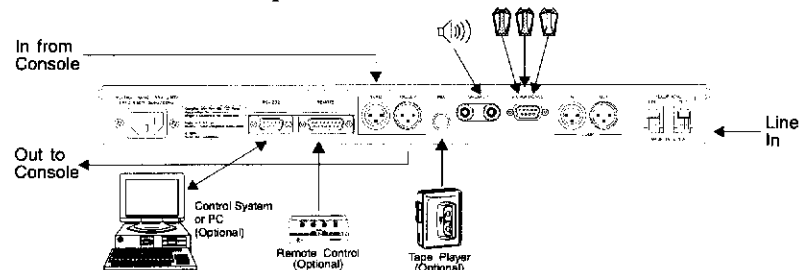

Figure 9. G3200 completed installation

Step 1 — Jumper Changes

Your G3200 is factory set to operate in the most common modes without internal jumper changes. However, when multiple hybrids are linked and callers must be separated, a jumper change is required (Table 1, below).

Table 1. Jumper Changes

| <u>Application:</u> | <u>Change Required:</u> |
|---|--|
| Single hybrid | No change. Jumpers remain 1-2, 6. |
| Callers mixed, multiple-G3200 loop (includes VIP setup) | No change. Jumpers remain 1-2, 6. |
| Callers separated, multiple-G3200 loop (includes VIP setup) | Change jumpers to 1-2, 5 on all looped hybrids. |
| Multiple-G3200 loop, meet-me-bridge | Change jumpers to 3-4, 6 on last looped hybrid only. |
| No Telco DC (dry line) | Change jumper JP1 to JP2 on Telco board. |

POWER NOTE:

To avoid electrical shock, you must disconnect all power to the unit before opening the chassis. Internal serviceable parts should only be accessed by a qualified technician.

To make jumper changes, loosen the four screws on the side panels of the G3200 unit. Lift the top cover and place it to the side.

Locate the jumpers (Figure 10, next page, top).

The PC-board labeling will show J1 through J6.

If the telephone line connected to the G3200 is a dry line (no DC), an internal jumper change will also be required. When making this change, ensure that auto-answer/auto-disconnect is OFF. When the unit is powered up, DC will be ignored, and auto-answer/auto-disconnect will no longer function.

Installation
Continued ≡

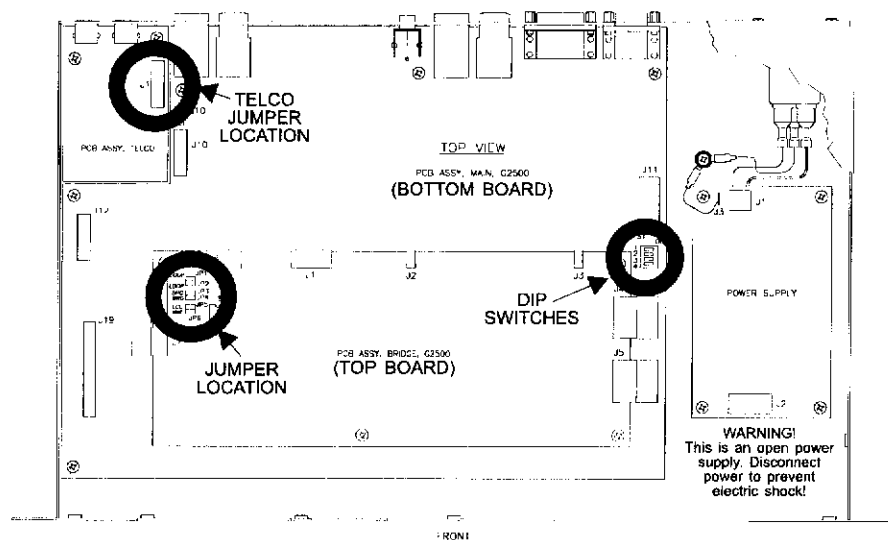

Figure 10. G3200 jumper locations

If making dip-switch changes, leave the G3200 cover off, *do not* apply power, then go on to Step 2 (below).

If no dip-switch changes are required, replace the G3200 cover, tighten all screws, *do not* apply power, then go to Step 3 (next page, top).

Step 2 — Dip-Switch Changes

Under normal operating conditions, dip-switch changes are not required. However, options are available (See Table 2, below.), should you want to make changes such as switching from acoustic echo-canceller mode to auto mix-minus mode (dip switch 1); these changes should be completed at the time the chassis is open while making jumper changes.

Table 2. Dip-Switch Changes

| Dip Switch No. | Default | Function/Alternate Operation |
|----------------|---------|---|
| 1 | Off | Switch ON to <i>activate</i> automatic mix-minus and <i>disable</i> acoustic mode. |
| 2 | Off | Switch ON to enable test tone for analog nulling (Operation, Page 17). |
| 3 | Off | Not used. |
| 4 | Off | Switch ON to enable a toggle-switch remote control and/or require that the ON button be held down in order to maintain call connection. |

POWER NOTE:

To avoid electrical shock, ensure that all power remains disconnected from the unit before opening the chassis. Internal serviceable parts should only be accessed by a qualified technician.

Locate the dip switches (See Figure 10, above.) and make necessary dip-switch changes.

When complete, replace the top cover and tighten the screws to close the chassis. *Do not* apply power yet.

Step 3 — Rack Mounting

Mount the unit in a standard 19" equipment rack using the screws and washers provided. *Do not* block any ventilation holes.

Step 4 — Back Panel Connections

The G3200's back panel has been designed with ease of installation in mind. Whichever configuration you use, installation will be quick and easy. The back-panel connectors are identified by number (See Figure 11, below.) for easy identification.

Figure 11. G3200 back-panel connections

VOLTAGE RANGE 85V - 240V
FREQUENCY 50 HZ / 60 HZ



Figure 12. G3200 power module

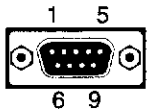

Figure 13. G3200 RS232 connector

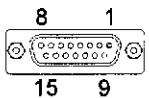

Figure 14. G3200 remote control DB15 connector



Figure 15. G3200 caller audio female XLR connector



Figure 16. G3200 male XLR caller connector

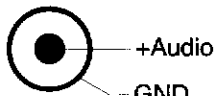
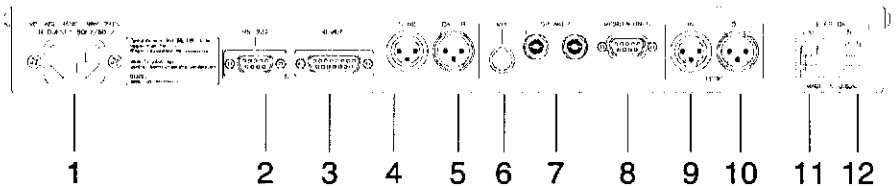

Figure 17. G3200 mix RCA jack



Figure 18. G3200 speaker connector



Power

The power module [1] (See Figure 12, left.) will operate at any level between 85–240Vac, 50–60Hz.

RS232

If a PC is to be used with your G3200, the RS232 nine-pin female connector [2] (See Figure 13, left.) allows you to use a straight-through cable to the PC's serial port. The serial port is set at 9,600 baud, eight bits, one stop bit, no parity. For serial-port commands, see Appendix B (Page 23); for pinouts, see Appendix A (Page 22).

Remote

Plug the customer-supplied remote control into the DB15 REMOTE connector [3] (See Figure 14, left.) to control mute and on/off functions (if using a contact-closure device). For pinouts, see Appendix A (Page 22).

Send

Connect send (program) audio from your console to the caller through the G3200 via the SEND XLR female connector [4] (Figure 15, left). If multiple units are looped together, apply send audio *only* to the first unit in the chain.

Caller

This is processed caller audio that will be sent to your console. While the caller can hear program audio through the G3200 SEND male XLR connector [5] (See Figure 16, left.), only caller audio is returned to the console. The G3200 filters out unwanted noise and echo from the telephone line and sends *only* clean audio to the console. If multiple G3200s are used, make the CALLER connection to the *last* unit in the chain.

Mix

If your application requires recording calls, insert the plug from your recording device into the MIX jack [6] (Figure 17, left).

Speaker

One 4ohm speaker can be directly connected to the G3200 (See Figure 18, left.), eliminating the need for a power amplifier. Connect the speaker wire to the + (red) and - (black) binding post connectors [7].

Installation
Continued ≡

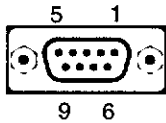

Figure 19. Microphone DB9 connector

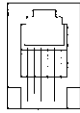

Figure 20. RJ11C telephone-line connector

Microphone

Plug up to three microphones into the provided three-way splitter. Plug the splitter into the MICROPHONE DB9 connector [8] (See Figure 19, left.) to take advantage of the G3200's internal microphone mixer. For pinouts, see Appendix A (Page 22).

Line

Connect the telephone line from your source to the RJ11C LINE jack [7] (Figure 20, left).

Set

Connect the telephone set cord to the RJ11C SET jack [8] (Figure 20, left).

If operating a single G3200, go to Calibration (Page 14). If operating more than one G3200 in loop formation, continue to Step 5 (below).

Step 5 — Loop Connections

Internal jumpers or dip-switch change, if required, should have been completed before mounting, making any back panel connections, plugging in power or making loop connections.

There are four looped-G3200 applications available (See Applications, Page 2.), with differing installation hookups: loop/mix, loop/separate, VIP and meet-me bridge.

Loop/Mix

Each G3200 contains a built-in loop in/out conference bus to allow several callers to be connected together, each using a dedicated G3200. The hybrids are connected with loop cables (one supplied with each hybrid). All active callers are automatically mixed together and presented at the last CALLER output connector [5] of the G3200 that is connected to the console.

The advantage with this mode is that only *one* SEND connection [4] (See Figure 21, below.) is made to the *first* G3200 from the console, and only *one* CALLER connection [5] is made to the console from the *last* G3200.

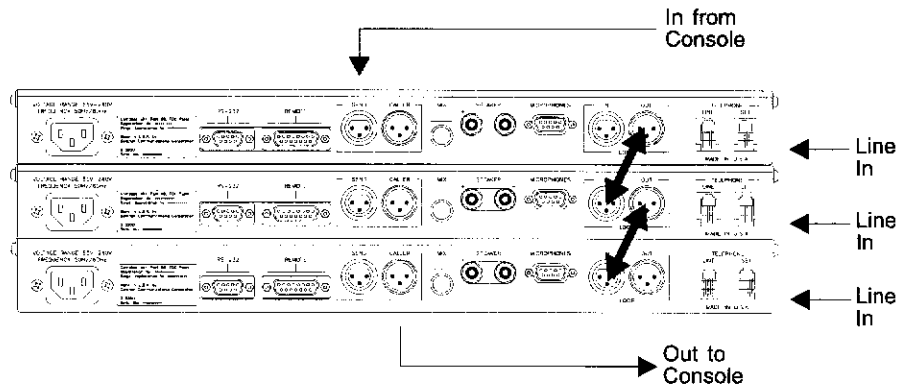

Figure 21. Multiple G3200 application with caller audio mixed

All internal jumpers will remain in the factory default setting.

Loop/Separate

All G3200s will be interconnected through the LOOP IN/OUT cable connectors [9, 10], yet callers will be separated. This is accomplished by connecting each CALLER output [5] (See Figure 22, next page, top.) to a separate pot on the console. Individual level control for each caller will be

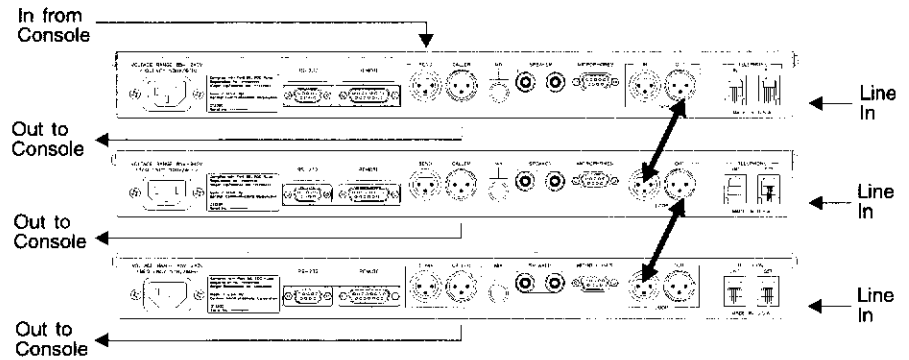

Figure 22. Multiple G3200 application with separate caller audio

available in this mode through the console.

The advantage with this mode is that only *one* SEND connection [4] is made from the console to the first G3200, then each G3200 CALLER output [5] connects to an individual input pot on the console. Each caller's volume can then be controlled individually from the console.

This application requires a jumper change on all G3200s to be looped together. Jumpers should have been changed to 1-2 and 5.

VIP Modes

The best way to protect your VIP caller is to place the VIP on a separate G3200, and configure all other G3200s in either the Loop/Mix or Loop/Separate mode. If callers are to be mixed, no internal jumper is needed on the looped hybrids. If separating callers is needed, an internal jumper change is required on the G3200s that will be looped together.

The advantage with this mode is that the level adjustment for your VIP can be monitored and adjusted from the console.

VIP Mode 1. Separate VIP G3200, with callers looped together and mixed caller audio (Figure 23, below).

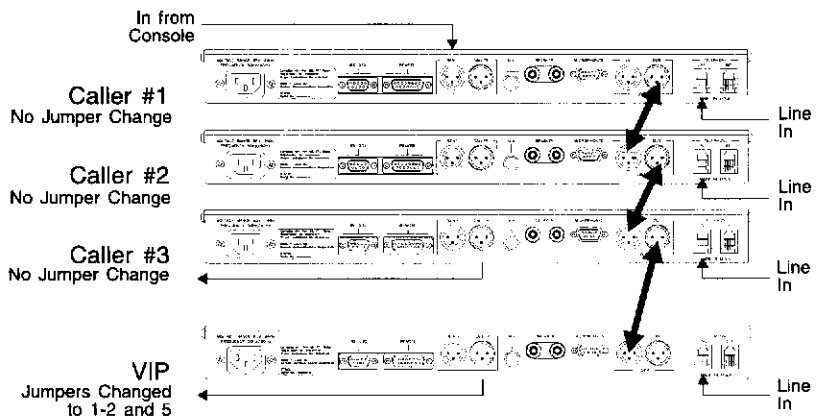

Figure 23. G3200 VIP mode 1

No internal jumpers need to be changed on callers' G3200s. Change the VIP G3200 jumpers to 1-2 and 5 in this mode. Loop the caller's G3200s with *last* G3200 connecting to the console. The VIP G3200 must be the *last* G3200 in the connected chain. Connect the VIP G3200 directly to the console.

Installation
Continued ≡

VIP Mode 2. Separate VIP G3200, with callers looped together and separated caller audio (Figure 24, below).

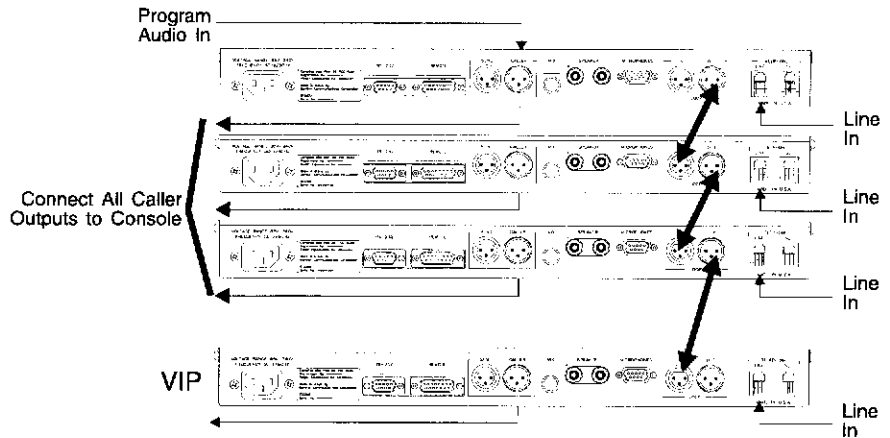

Figure 24. G3200 VIP mode 2

Internal jumpers must be set to 1-2 and 5 on all units. Connect the VIP G3200 directly to the console. Loop the callers' G3200s as shown and connect each CALLER output [5] to the console.

Meet-Me Bridge

For meet-me bridge operation (See Figure 25, below.), with up to eight callers' audio mixed, you must have mix-minus from your console.

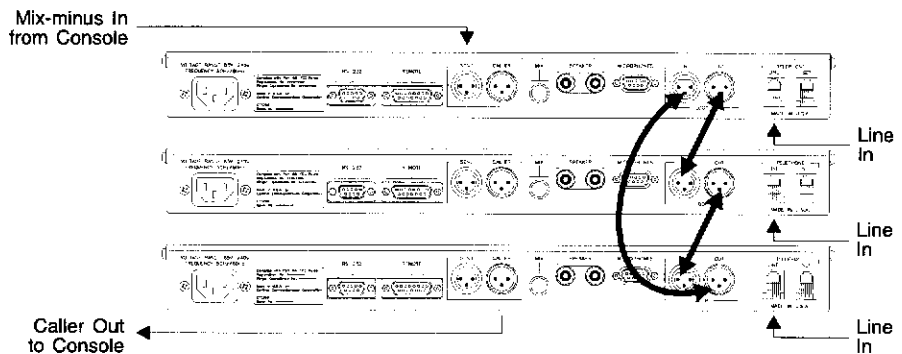

Figure 25. G3200 Meet-me bridge

The advantage with this mode is that callers can each dial in from separate locations at an assigned time, and hang up independently (when needed), while still maintaining audio quality for all participants.

An internal jumper change must be set on 3-4 and 6 on the last G3200 only to enable this mode. G3200s will be interconnected through loop cable connections.

Calibration 

The following information will help you make adjustments to optimize your system performance. Verify all components and all connections. Ensure that proper power is supplied to the G3200 and that the unit is OFF (the red OFF LED will be lit). If the green ON LED is lit, press the OFF button [14].

Front Panel Controls

Figure 26 (below) shows each LED, trim pot, switch and button by number for easy identification.

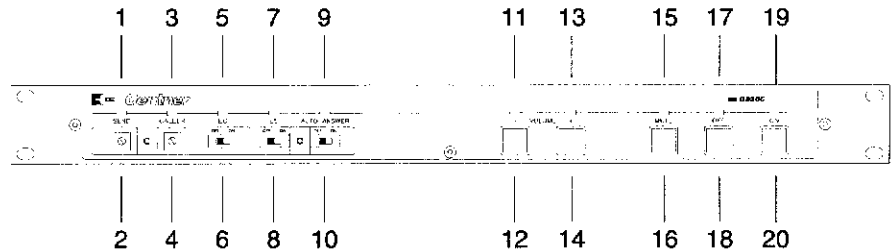

Figure 26. G3200 front-panel controls

CALIBRATION NOISE NOTE:

Some echo and ringing may be heard while calibrating the G3200. Disregard it and continue with calibration until the end of the procedure. The echo and ringing will disappear.

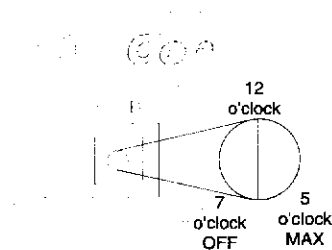

Figure 27. G3200 trim-pot locations

The SEND [2] and CALLER [4] trim pots should be in the 12 o'clock position (Figure 27, left).

If using the G3200's automatic mix-minus:

Verify that dip switch 1 is ON for mix-minus mode.

The EC switch [6] should be ON (its LED [5] will be lit green).

The ES switch [8] should be OFF.

AUTO MIX-MINUS NOTE:

When in auto mix-minus mode, the acoustic echo-canceller mode is disabled.

If using the G3200 as an acoustic echo canceller:

Verify that dip switch 1 is OFF for acoustic echo-canceller mode.

The EC switch [6] should be ON (its LED [5] will be lit green).

The ES switch [8] should be OFF.

The AUTO-ANSWER switch [10] can be *either* ON or OFF. If ON, the AUTO-ANSWER LED [9] will glow green. If OFF, its LED will glow red.

MUTE [12] should be OFF (its LED [11] will not be lit).

ACOUSTIC ECHO CANCELLER NOTE:

When in acoustic echo-canceller mode, the auto mix-minus mode is disabled.

Step 1 — Trim Pot Levels

Due to the various operating modes (single G3200, multiple G3200s with callers mixed, multiple G3200s with callers separate, meet-me bridge) front-panel level settings will need to be preset as follows:

Single G3200

Set both the SEND trim pot [2] and CALLER trim pot [4] at the 12 o'clock position.

Calibration
Continued ≡

Multiple G3200s with Callers Mixed

Set the *first* G3200's SEND trim pot [2] at 12 o'clock, and all other G3200 SEND trim pots [2] at 7 o'clock (full off).

Set the *last* CALLER trim pot [4] at 12 o'clock (See Figure 28, below.) and all other G3200 CALLER trim pots [4] at 7 o'clock (full off).

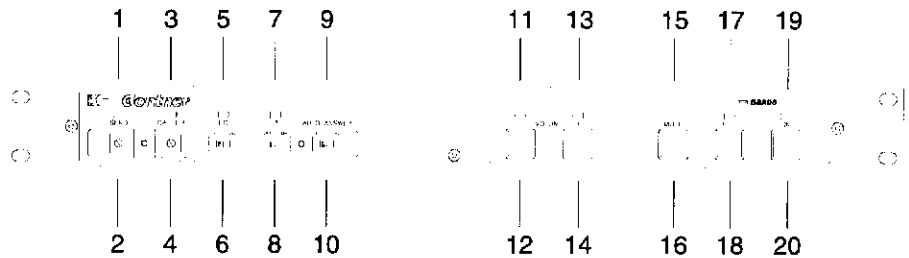

Figure 28. Front-panel controls

Multiple G3200s with Callers Separate

Set the *first* G3200's SEND trim pot [2] at 12 o'clock, and all other G3200 SEND trim pots [2] at 7 o'clock (full off).

Set *all* CALLER trim pots [4] at 12 o'clock. (Each CALLER output is connected directly to the console.)

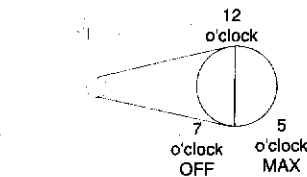

Figure 29. G3200 trim-pot locations

Meet Me Bridge

All SEND trim pots [2] and CALLER trim pots [4] should be set at 12 o'clock (Figure 29, left).

Step 2 — Caller Adjustment

From another location, have someone call the G3200 (*first* G3200 if interconnecting multiple G3200s). Answer the line by pressing the ON button [16]. (If the auto-answer feature is active, the unit will answer the call after one complete ring.)

The caller will hear a short white noise burst (it will sound like static) and a short beep. This automatically adapts the G3200 to the telephone line.

As the caller talks, adjust *only* the active CALLER trim pot(s) [4] identified in Step 1 (above), and/or your mixing board for a correct level going into your board.

CALLER LED NOTE:

The CALLER trim pot [4] has no effect on the CALLER LED [3]. The CALLER LED indicates actual level on the phone line only.

Step 3 — Send Adjustment

Send program audio. Adjust your console or active SEND trim pot(s) [2] until the SEND LED [1] is green. Occasional red peaks are OK. (If you are *not* using automatic mix-minus, skip to Step 4, below.)

Watch the SEND LED [1] as the caller speaks. If the LED peaks red frequently or peaks red before the CALLER LED [3], turn the SEND trim pot [2] down (counterclockwise, toward 7 o'clock) until the frequency of red peaks declines.

After several calls have been made and the automatic mix-minus has had a chance to adapt to the console environment, the ES switch [8] may be turned

OFF.

Step 4 — Setup Routine

A setup routine, either adapting or electronic, is required to complete calibration.

Adapting

Continue making or taking calls while the system adapts over time. This setup routine takes up to 20 minutes (while the caller speaks) for the system to adapt to its optimum level. You will notice that the EC LED [5] rarely flashes red once the system has adapted properly. When complete, turn the ES switch [6] OFF. The ES switch will remain OFF under normal operating conditions.

Electronic

The electronic method takes only a few seconds, while a white noise burst is transmitted. This method may be objectionable if the G3200(s) is being used on-air during setup.

Make sure the audio paths and levels from the G3200 are set to normal on-air operation, then call the hybrid and answer the phone.

Press and continue to hold the MUTE button [16] and momentarily press the OFF button [18], then release both buttons. A white noise burst will be transmitted for 20 seconds or less through the caller output. If during the white noise burst, if the SEND LED [1] is red, turn down the SEND trim pot [2] (counterclockwise, toward 7 o'clock). This forces the automatic mix-minus to quickly adapt to the console environment.

If, during normal conversation, both the EC and ES LEDs [5, 7] are green, turn the ES switch [6] OFF. If the EC LED [5] turns solid red while the calling party is speaking at normal levels, turn the ES switch [6] back ON.

If the ES or EC LEDs [5, 7] flash red when both switches are ON, a mic/speaker level adjustment is recommended.

Once complete, the G3200 will be fully calibrated and ready for use.

MIC/SPEAKER CALIBRATION NOTE:

If any additional adjustments are made on the front panel, or if any mics/speakers are moved after setup is complete, perform an additional setup routine.

Conclude your conversation and press the OFF button [18]. (If the auto-answer/auto-disconnect feature is active, the hybrid will disconnect the call upon sensing loop drop.)

POWER-FAILURE NOTE:

In the event of a power failure, a complete setup routine must be repeated. Switches will remain in the position prior to the outage. A complete setup routine must be completed. The ES switch [8] should be in the OFF position for normal operation. If you turn it ON, the echo suppression on program audio will be activated resulting in an 18dB ducking of the program to the caller when the caller speaks.

Operation 

Easy-to-access and read front-panel controls make operation of the G3200 simple. Figure 30 (below) shows each front panel LED, switch and button by number.

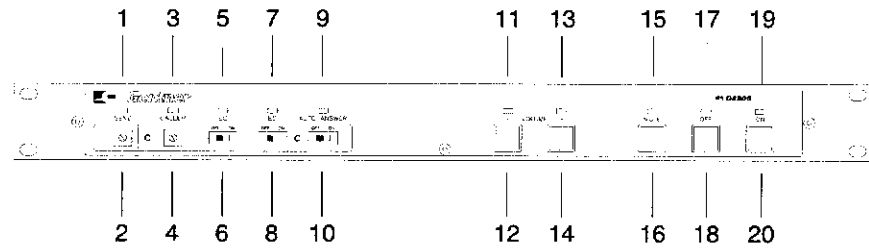

Figure 30. Front-panel controls

Answering a Call

An incoming call will ring on the telephone set. The AUTO-ANSWER LED [9] will flash rapidly during each ring. Answer the call by pressing the ON button [20] on either the front panel or from your remote control. This will route the call through the G3200, and the green ON LED [19] will light. The red OFF LED [17] will dim. Upon connection, the G3200 automatically rerolls.

Or

If you want to talk *off-air*, you can answer the call by picking up the telephone handset and talking to your party over the telephone. *Do not* activate the G3200; your call *will not* be handled by the hybrid.

Making a Call

Off-Air

The G3200 should be OFF (the red OFF LED [17] will be lit). Using your telephone set, dial the phone number of the party you wish to call. Conduct your call as you normally would and hang up the handset when finished.

On-Air

Call the party normally, using your handset. After the other party has answered, put the call on-air by pressing the ON button [20]. The ON LED [19] will light and the G3200 will take control of the call, disabling the telephone set. You may safely hang up the handset without disconnecting your call. When the conversation is complete, press the OFF button [18] to disconnect the call.

Disconnecting a Call

If the call is routed through the G3200 (the ON LED [19] will be lit), press the OFF button [18]. The OFF LED [17] will light, and the ON LED [19] will extinguish.

If your call is through the handset only (the red OFF LED [17] will be lit), hang up when the conversation is complete.

Auto-Answer/Auto-Disconnect Mode

Activating Auto-Answer/Auto-Disconnect

To put the G3200 in auto-answer mode, move the AUTO-ANSWER switch [10] to the ON position. (Its green LED [9] will light.) In the auto-answer mode, the G3200 will automatically answer telephone calls after one complete ring. Upon answering, the red OFF LED [17] will extinguish and

the green ON LED [19] will light. Your call will be routed through the G3200 and its connection to the console.

When the call is terminated, the hybrid will sense loop drop and automatically turn the G3200 OFF, extinguishing the green ON LED [19] and lighting the red OFF LED [17].

AUTO-ANSWER/AUTO-DISCONNECT NOTE:

This mode may not function as described with some PBX systems. The difficulty with the auto-answer mode may be caused by ring timing. Auto-disconnect requires loop drop or loop reversal to function. Contact your telephone company for this signaling.

Terminating Auto-Answer/Auto-Disconnect

Move the AUTO-ANSWER switch [10] to OFF position. The green LED [9] will extinguish and the red OFF LED [17] will light.

Mute Caller Audio

While on an active call, press the MUTE button [16]. This mutes *only* the caller audio to the console, and does not disconnect the call. Program audio will still be sent to the caller. When the G3200 is OFF, the mute function does not function.

Remote Control Option

A customer-supplied remote control or contact-closure switch can be used to perform three functions: mute on/off, system on and system off.

If using a remote-control device, internal dip switch 4 will select a momentary or latching ON closure. See Table 2, Page 10.

Recording Option

To record a call, your recording device must be connected to the MIX connector on the G3200's back panel. While on a connected call, the mix of both SEND and RECEIVE audio will be routed to the mix connector. Turn on your recording device and set it to record. Turn the recording device off when the call is finished.

RECORDING QUALITY NOTE:

This mix is not broadcast audio quality, and is to be used for reference only. To record broadcast audio quality, you must supply a mix from your console to your recording device.

Performing an Analog Null

If you notice that the standard calibration digital null is not performing well (i.e., the announcer has a hollow sound when speaking with someone over the telephone line), you may need to perform an analog null. Performing an analog null will more closely match the G3200 circuit to your telephone line.

POWER NOTE:

Only a qualified technician should perform this procedure. An exposed power supply is immediately accessible when the chassis cover is removed. This

Operation
Continued ≡

procedure requires that all power to the system be maintained while making the null adjustment. Take all precautions necessary to prevent touching the power supply. Severe shock could result if the power supply is touched.

Step 1
 Remove the lid.

Step 2
 Locate and move dip switch 2 (See Figure 31, below.) to the ON position. This activates the internally generated null tone.

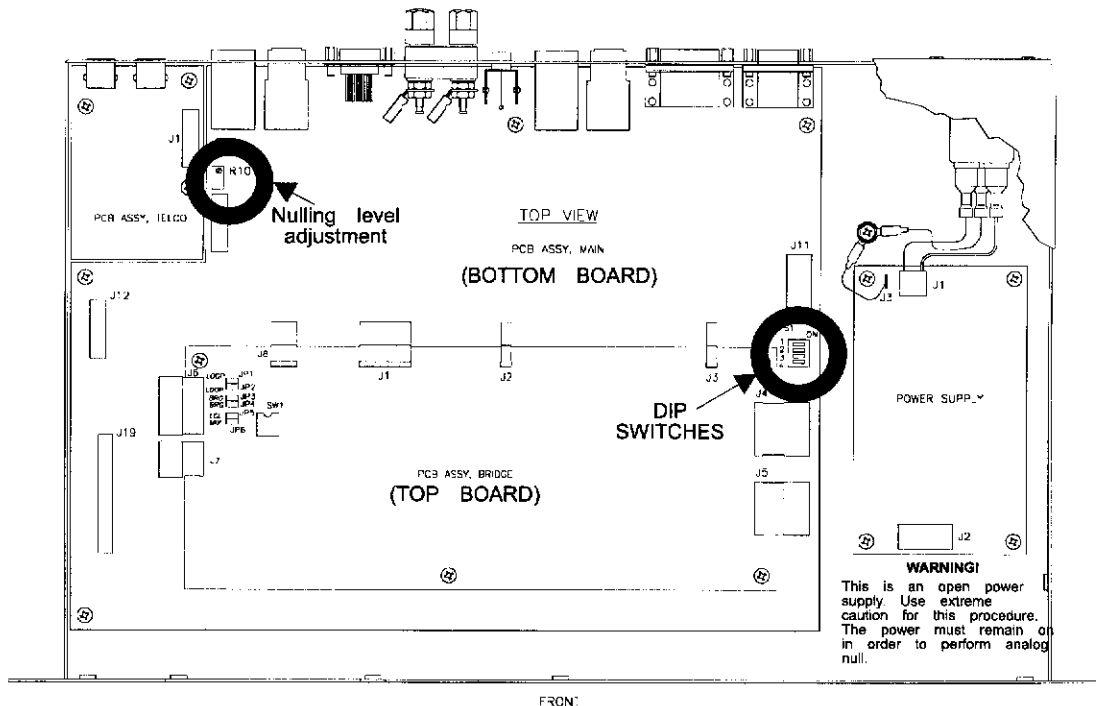

Figure 31. G3200 jumper locations

Step 3
 Call the G3200. When the G3200 connects to the telephone line, the null tone is sent down the phone line. Using the meter on your console, monitor the caller output.

METERING NOTE:

If you are not connected to a console containing a meter, a voltmeter is sufficient.

Step 4
 While monitoring the caller output, adjust trim pot R10 for a minimum level from the caller output.

Return dip switch 2 to the OFF position and replace the lid.

Emergency Restoration

Following a power failure or disconnection of power, a setup routine will need to be activated on each G3200 to achieve optimum performance (see Step 4 — Setup Routine, Page 16). A telephone call that was active when the power loss occurred will need to be redialed.

When Not in Use

The G3200 is inactive when the red OFF LED [17] lit.

If the AUTO-ANSWER switch [10] is OFF, the red OFF LED [17] will be lit and the green ON LED [19] will be dim. If the AUTO-ANSWER switch [10] is ON, the green ON LED [19] will be lit and the red OFF LED [17] will be dim.

POWER NOTE:

Power should be maintained to the unit at all times.

Specifications 

G3200

Dimensions

19"/48.3cmW x 1.75"/4.45cmH x 10"/25.4cmD

Weight

10 lbs./4.5 kg (dry) 13 lbs./5.9 kg (shipping)

Connectors

POWER: Auto-adjusting power module
RS232: DB9 female serial port
REMOTE: DB15 female; inputs active on closure to ground at 20mA sink current.
SEND: 3-pin female XLR; balanced bridging >20k Ω input impedance; +4dBu nominal level, adjustable
CALLER: 3-pin male XLR; balanced; 600 Ω output impedance adjustable from 0–20dBu into 600 Ω ; termination +4dBu nominal level.
SPEAKER: Dual five-way binding posprt for 4ohm speaker
MICROPHONE: DB9 female connector
LOOP IN: 3-pin female XLR; unbalanced transmit/receive audio at 0dBu operation level
LOOP OUT: 3-pin male XLR; unbalanced transmit/receive audio at 0dBu operation level
LINE/SET: RJ11C
RECORD: Phono; 300Hz to 3300Hz

Power Requirements

85–240Vac, 50/60Hz; (Fuse) 2 amp Slo-Blo type for 250Vac; power consumption typically 18W.

Frequency Response

300Hz to 3.4kHz; ± 1 dB with 6dB pre-emphasis on send

Distortion

< 0.1 percent THD at 1kHz Telco LINE to CALLER; 1 percent THD at +20dBu at CALLER using 1kHz tone

Noise

> 60dBu at CALLER

Operating Temperature

32–100° F; humidity 0–80 percent

Cables

- 6-foot power cord
- 12-foot telephone cord with RJ11C jacks on both ends
- 12-inch microphone cable with DB9 connector on one end and other end split into three XLR connectors
- 12-inch loop cable containing one male XLR and one female XLR

Specifications are subject to change without notice.

Warranty ≡

Gentner Communications Corporation (Manufacturer) warrants that this product is free of defects in both materials and workmanship. Should any part of this equipment be defective, the Manufacturer agrees, at its option, to:

A. Repair or replace any defective part free of charge (except transportation charges) for a period of one year from the date of the original purchase, provided the owner returns the equipment to the Manufacturer at the address set forth below. No charge will be made for parts of labor during this period;

B. Furnish replacement for any defective parts in the equipment for a period of one year from the date of original purchase. Replacement parts shall be furnished without charge, except labor and transportation.

This Warranty excludes assembled products not manufactured by the Manufacturer whether or not they are incorporated in a Manufacturer product or sold under a Manufacturer part or model number.

THIS WARRANTY IS VOID IF:

A. The equipment has been damaged by negligence, accident, act of God, or mishandling, or has not been operated in accordance with the procedures described in the operating and technical instructions; or,

B. The equipment has been altered or repaired by other than the Manufacturer or an authorized service representative of the Manufacturer; or,

C. Adaptations or accessories other than those manufactured or provided by the Manufacturer have been made or attached to the equipment which, in the determination of the Manufacturer, shall have affected the performance, safety or reliability of the equipment; or,

D. The equipments original serial number has been modified or removed.

NO OTHER WARRANTY, EXPRESS OR IMPLIED, INCLUDING WARRANTY OF MERCHANTABILITY OR FITNESS FOR ANY PARTICULAR USE, APPLIES TO THE EQUIPMENT, nor is any person or company authorized to assume any warranty for the Manufacturer or any other liability in connection with the sale of the Manufacturer's products.

Manufacturer does not assume any responsibility for consequential damages, expenses, or loss of revenue or property, inconvenience, or interruption in operation experienced by the customer due to a malfunction in the purchased equipment. No warranty service performed on any product shall extend the applicable warranty period.

In case of unsatisfactory operation, the purchaser shall promptly notify the Manufacturer at the address set forth below in writing, giving full particulars as to the defects or unsatisfactory operation. Upon receipt of such notice, the Manufacturer will give instructions respecting the shipment of the equipment, or such other matters as it elects to honor this warranty as above provided. This warranty does not cover damage to the equipment during shipping and the Manufacturer assumes no responsibility for such damage. All shipping costs shall be paid by the customer.

This warranty extends only to the original purchaser and is not assignable or transferable.

Gentner Communications Corporation, 1825 Research Way, Salt Lake City, Utah 84119

**FCC Part 15
Compliance** ≡

This equipment has been tested and found to comply with the limits for a Class A digital device, pursuant to Part 15 of the FCC rules. These limits are designed to provide reasonable protection against harmful interference when the equipment is operated in a commercial environment. This equipment generates, uses, and can radiate radio frequency energy and, if not installed and used in accordance with the instruction manual, may cause harmful interference to radio communications. Operation of this equipment in a residential area is likely to cause harmful interference, in which case the user will be required to correct the interference at his/her own expense.

Changes or modifications not expressly approved by Gentner Communications Corporation could void the user's authority to operate the equipment.

**FCC Part 68
Compliance** ≡

**FCC Registration Number: FBI?
The Ringer Equivalence Number (REN) is 1.1B**

A label containing, among other information, the FCC registration number and Ringer Equivalence Number (REN) for this equipment is prominently posted on the top plate, near the rear of the equipment. If requested, this information must be provided to your telephone company.

USOC Jacks: This device uses RJ11-C and RJ21X terminal jacks.

The REN is used to determine the quantity of devices which may be connected to the telephone line. Excessive RENs on the telephone line may result in the devices not ringing in response to an incoming call. In most, but not all areas, the sum of the RENs should not exceed five (5). To be certain of the number of devices that may be connected to the line, as determined by the total RENs, contact the telephone company to obtain the maximum RENs for the calling area.

If this equipment causes harm to the telephone network, the telephone company will notify you in advance that temporary discontinuance of service may be required. If advance notice is not practical, the telephone company will notify the customer as soon as possible. Also, you will be advised of your right to file a complaint with the FCC if you believe it is necessary.

The telephone company may make changes in its facilities, equipment, operations, or procedures that could affect the operation of the equipment. If this happens, the telephone company will provide advance notice for you to make the necessary modifications in order to maintain uninterrupted service.

If you experience problems with this equipment, contact Gentner Communications Corporation, 1825 Research Way, Salt Lake City, Utah 84119, or by phone at (801) 975-7200 for repair and warranty information. If the trouble is causing harm to the telephone network, the telephone company may request you remove the equipment from the network until the problem is resolved.

No user serviceable parts are contained in this product. If damage or malfunction occurs, contact Gentner Communications for instructions on its repair or return.

This equipment cannot be used on telephone company provided coin service. Connection to Party Line Service is subject to state tariffs.

IC Compliance ≡

NOTICE: The Industry of Canada label identifies certified equipment. This certification means that the equipment meets certain telecommunications network protective operational and safety requirements. The Department does not guarantee the equipment will operate to the user's satisfaction.

Before installing this equipment, users should ensure that it is permissible to be connected to the facilities of the local telecommunications company. The equipment must also be installed using an acceptable method of connection. In some cases, the company's inside wiring associated with a single line individual service may be extended by means of a certified connector assembly (telephone extension cord). The customer should be aware that compliance with the above conditions may not prevent degradation of service in some situations.

Repairs to certified equipment should be made by an authorized Canadian maintenance facility designated by Gentner Communications. Any repairs or alterations made by the user to this equipment, or equipment malfunctions, may give the telecommunications company cause to request the user to disconnect the equipment.

Users should ensure for their own protection that the electrical ground connections of the power utility, telephone lines and internal metallic water pipe system, if present, are connected together. This precaution may be particularly important in rural areas.

The Ringer Equivalence Number (REN) is 1.1
IC Certification Number:

**Safety
Information** ≡

CAUTION: Users should not attempt to make such connections themselves, but should contact the appropriate electrical inspection authority, or electrician, as appropriate.

BABT Recording Requirements

This condition applies in circumstances where you wish to use telecommunications apparatus comprised in or connected to your system to record, silently monitor or intrude into live-speech telephone calls. (It does not apply where the apparatus in question is not telecommunications apparatus; i.e. is not apparatus that had been constructed or adapted for use in transmitting or receiving telecommunications messages.) Silent monitoring is the establishment of a receive-only transmission path to a third terminal, enabling a third party to hear the call. Intrusion is the establishment of a bothway speech transmission to another terminal enabling a third party to hear and be heard by at least one of the other parties to the call. The condition does not apply to the monitoring of telephone calls for a systems control or diagnostic purposes where the meaningful content of the call itself is monitored.

This condition provides that you should make every reasonable effort to inform all parties to a call that it may or will be recorded, silently monitored or intruded into. The particular means by which you choose to do this are not specified in the condition. Acceptable options, depending on circumstances, might include warning tones, prerecorded messages, spoken warnings by the operator or written warnings included in publicity material, telephone directories, contracts, terms of business, staff notices, etc. It may not always be possible to warn first-time callers with whom you have had no previous contact but what is important is that you have a systemic procedure in place which provides the necessary information wherever this is a realistic possibility.

For recording and silent monitoring, this condition recognises two forms of warning: a written notice before the call or a warning during the call itself. Both warnings should also inform all parties to a call why it is being recorded or silently monitored. In the case of intrusion, a warning before the intrusion takes place is sufficient as both parties will become aware that a third party has joined their conversation.

This condition does not specify the detail of how these forms of warning should be given. A written statement included in any of the following — contractual terms, conditions of employment, publicity material, staff notices, telephone directory entries — would be a possible method.

The essential point is that the equipment user must be able to demonstrate that a determined attempt has been made to reach prospective callers; as an illustration, we would expect any warning included in a company's publicity material to be presented in such a way that it would not be missed by anyone looking for that company's telephone number(s). A warning which is not clearly visibly would fail to meet this requirement.

Where the warning is to be given during the call itself, the possibilities include a recorded message at the beginning of the call or a spoken message at any time during the conversation.

You should also maintain a record of the means by which callers have been warned which the Director may request sight of. This does not mean that you have to log each phone call; rather, that should a dispute arise, it will be possible for you to show from records how callers were being made aware at the time.

This condition does not apply where apparatus is being used for the purpose of law enforcement or in the interests of national security or to calls involved the national Emergency Organisations. It also provides that other licensees may be excluded, by means of a Director's consent, where there are compelling factors that outweigh the normal expectation of privacy. Such factors might apply where security is a consideration or in the case of specialised users such as helplines. In accordance with Section 19 of the Telecommunications Act of 1984, these consents will be entered on a register open to public inspection.

This condition attempts to secure objectives similar to those which were previously achieved through an approval requirement that equipment capable of recording, silently monitoring or intruding into telephone conversations should emit warning tones as these operations take place. The removal of warning tones was permitted by an OFTEL General Variation provided that an alternative form of warning was given. The expectation is that procedures complying with the General Variation should, generally, also meet the requirements of this condition.

Appendix A: Connector Pinouts

Table 3. Remote Control DB15 Connector Pinouts

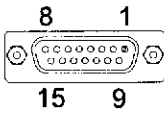

| Pin Number | Control | Pin Number | Control |
|------------|-------------|------------|------------|
| 1 | Ground | 9 | Ground |
| 2 | On | 10 | On lamp |
| 3 | Off | 11 | Off lamp |
| 4 | Mute On/Off | 12 | Mute lamp |
| 5 | Not in use | 13 | Not in use |
| 6 | Not in use | 14 | Not in use |
| 7 | Not in use | 15 | Not in use |
| 8 | Not in use | | |

Table 4. RS232 DB9 Connector Pinouts

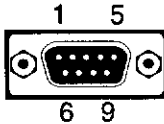

| Pin Number | Control | Pin Number | Control |
|------------|----------|------------|---------------|
| 1 | DCD | 6 | DSR |
| 2* | Transmit | 7 | No connection |
| 3* | Receive | 8 | CTS |
| 4 | DTR | 9 | No connection |
| 5* | Ground | | |

* Required for computer or remote control

Table 5. Telephone Set and Line Connections

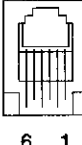

| | Telephone Set | | Telephone Line |
|---|----------------|---|----------------|
| 1 | No Connection | 1 | No Connection |
| 2 | A-lead closure | 2 | A-lead closure |
| 3 | Ring | 3 | Tip |
| 4 | Tip | 4 | Ring |
| 5 | A-lead closure | 5 | A-lead closure |
| 6 | No connection | 6 | No Connection |

Table 6. DB9 Microphone Connector Pinouts

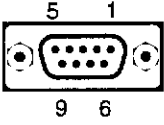

| Pin Number | Control | Pin Number | Control |
|------------|---------|------------|---------|
| 1 | Mic 1+ | 6 | Mic 3- |
| 2 | Mic 1- | 7 | Ground |
| 3 | Mic 2+ | 8 | Ground |
| 4 | Mic 2- | 9 | Ground |
| 5 | Mic 3+ | | |

Appendix B: Serial Port Commands

The RS232 serial port will accept serial commands. The commands provide the same control as the following front-panel switches: ON, OFF, VOLUME -, VOLUME + and MUTE.

RS232 Serial Port Protocol

9600 baud, 8 bits, 1 stop bit, no parity

```
G3200 Super Hybrid
Gentner Communications Corporation © 1993

Ports Initialized

G3200 POC vx.x
RAM OK
CODEC OK
G3200

INTERRUPTS $Revision: x.xx$
INTERRUPTS SETUP $Revision: x.xx$
BACKGROUND $Revision: x.xx$
G3200 MONITOR $Revision: x.xx$
```

When the serial port is connected to a computer, the information in Figure 32, (left) will be displayed on the screen on power-up:

SERIAL PORT NOTE:

Placing 3 milliseconds of character spacing between commands will reduce the chance of missed commands. It is also best to wait for the G3200 to acknowledge a command before going on to the next one.

The G3200 is now in the serial command mode. The G3200 serial commands taken in this mode are shown in Table 7 (below). These commands are designed to allow users to control the G3200 through the serial port.

Figure 32. G3200 power-up message

The basic structure of the serial commands are one or two letters with a digit following the letters. The two letters identify the command type. The digit or lack of a digit tells the G3200 what to do with the current command.

Table 7. G3200 Serial Port Commands

| Function | Command | Function | Command |
|-------------|---------|-----------|---------|
| Mute | P | Setup | S |
| Telephone | TE | Volume Up | L+ |
| Volume Down | L- | | |

SERIAL COMMAND NOTE:

All commands are not complete until you hit ENTER.

Telephone

The TE command has the same function as the ON button. It connects or disconnects the G3200.

TE1 <CR>

Connects the G3200.

The G3200 responds, TE1 <CR> (if connected) or TE0 <CR> (if not connected).

TE0 <CR>

Disconnects the G3200.

The G3200 responds, TE0 <CR>.

TE <CR>

Returns the on/off connect state. or TE0

The G3200 responds, TE1 <CR> if connected

<CR> (if not connected).

Mute

The G3200's mute mode will work only if the G3200 is connected to the telephone lines (ON mode). To enable the mute through the serial port, send the following characters:

P1 <CR>

Enables mute mode.

The G3200 responds, P1 <CR>.

P0 <CR>

Disables mute mode.

The G3200 responds, P0 <CR>.

P <CR>

Returns the current status of mute.

The G3200 responds, P1 <CR> (if privacy is enabled) *or* P0 <CR> (if privacy is disabled).**Setup**

To put the G3200 into setup mode, send

S1 <CR>

Puts the G3200 into setup mode.

The G3200 responds, S1 <CR>.

S0 <CR>

Takes the G3200 out of setup mode.

The G3200 responds, S0 <CR>.

S <CR>Returns the current status of setup mode.
mode) *or* S0The G3200 responds, S1 <CR> (if in setup
<CR> (if not in setup mode).**SETUP EXIT NOTE:***The setup training will timeout after 25 seconds.***Volume Up and Volume Down**

The volume up command is initiated by sending the following characters:

L+ <CR>

Increases the volume level.

The G3200 responds, L+ <CR>.

L- <CR>

Decreases the volume level.

The G3200 responds, L- <CR>.

Status

A special command returns the entire status of the G3200 in one command. The character string for the command is

ST <CR>

Returns the entire G3200 status.

The G3200 responds in the following order:

Sx

Lxx

Px

TE_x

**Appendix C: PC Command
Quick Reference** 

| | |
|----------|------------------------------|
| TE <CR> | Return on/off connect status |
| TE1 <CR> | Connect |
| TE0 <CR> | Disconnect |
| P <CR> | Return mute status |
| P1 <CR> | Enables mute |
| P0 <CR> | Disables mute |
| S <CR> | Return current setup status |
| S1 <CR> | Enable setup |
| S0 <CR> | Disable setup |
| ST <CR> | Return all above status |
| L+ <CR> | Volume up |
| L- <CR> | Volume down |

**Appendix D: G3200
Block Diagram**

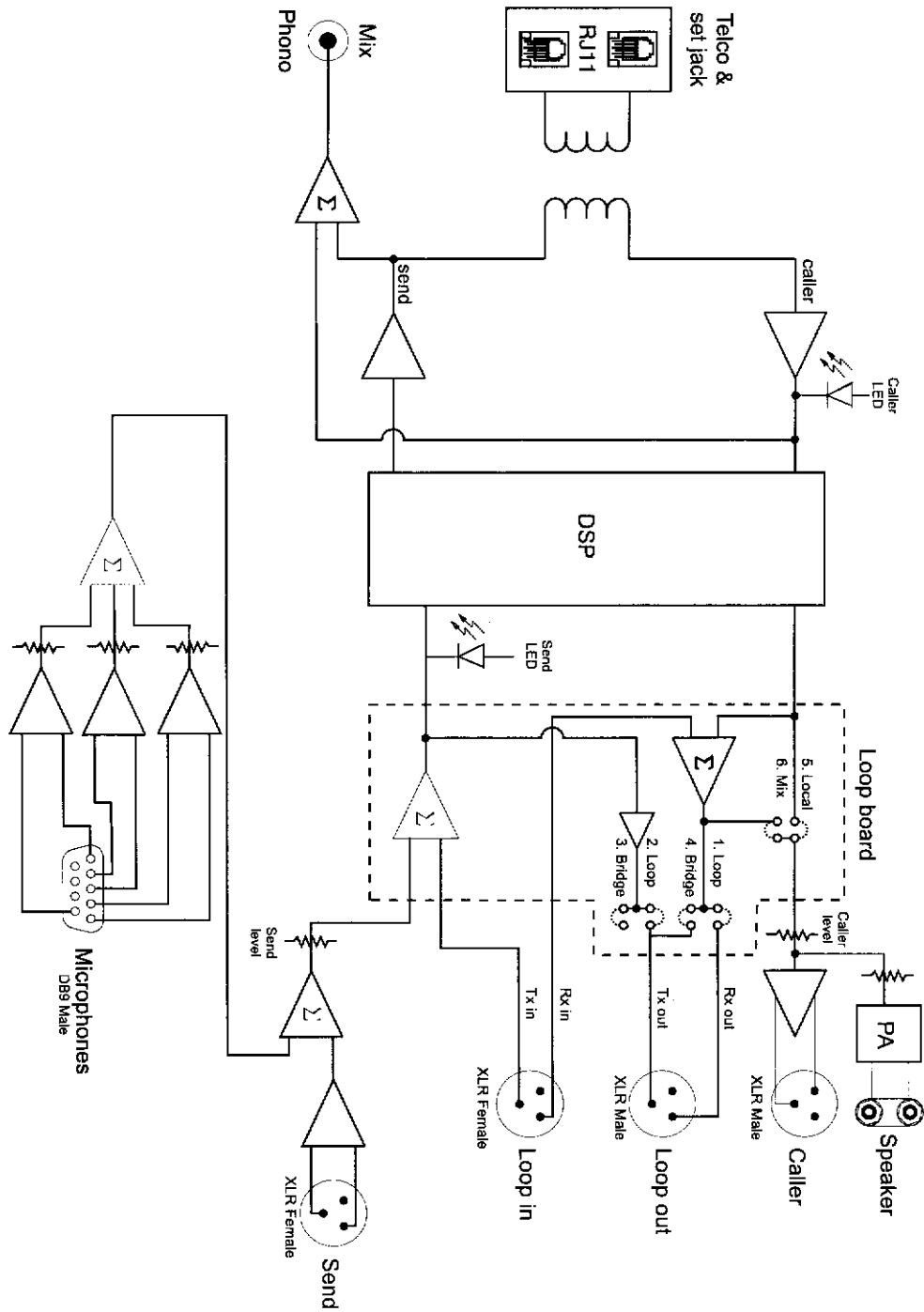

Appendix E: G3200 Schematics

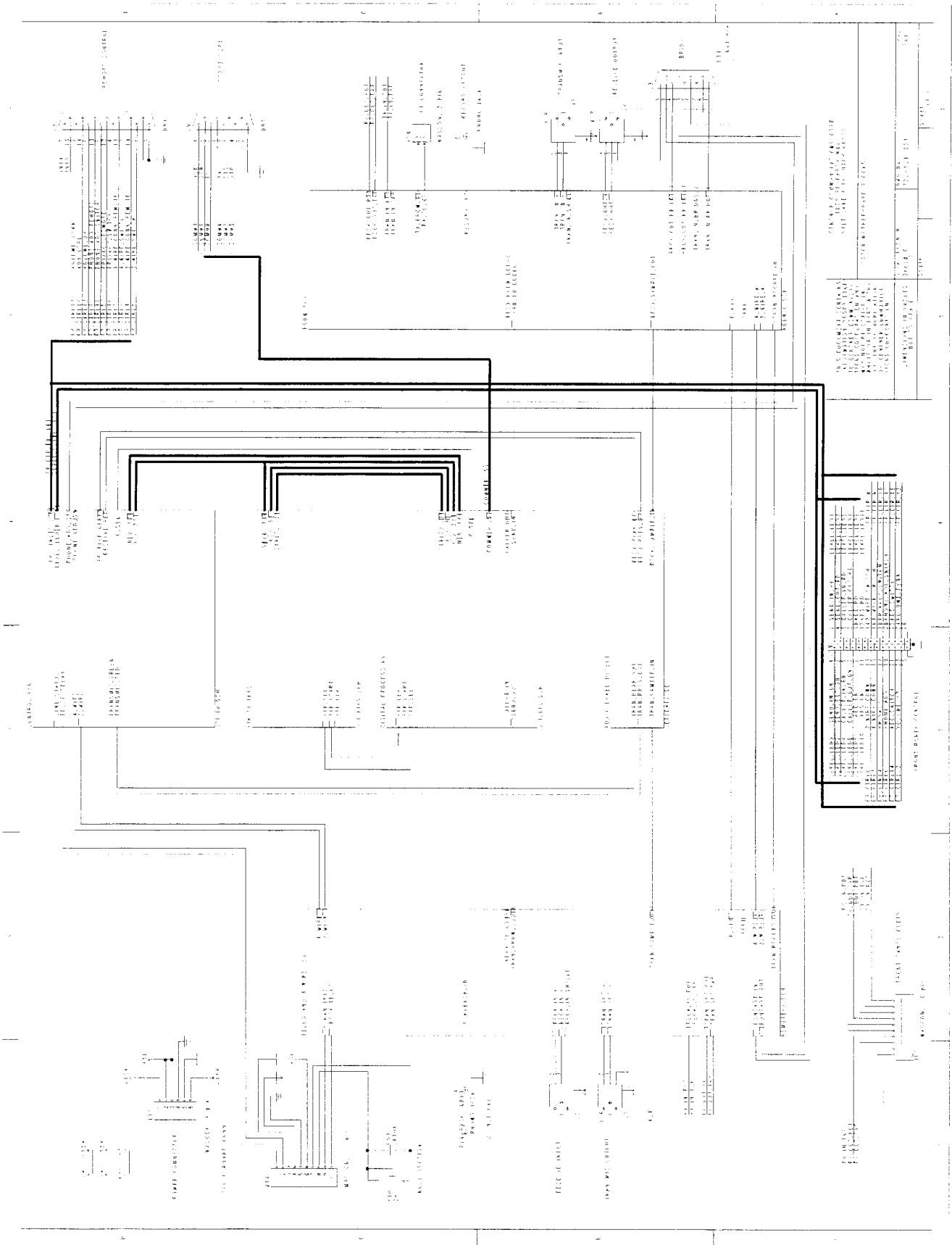

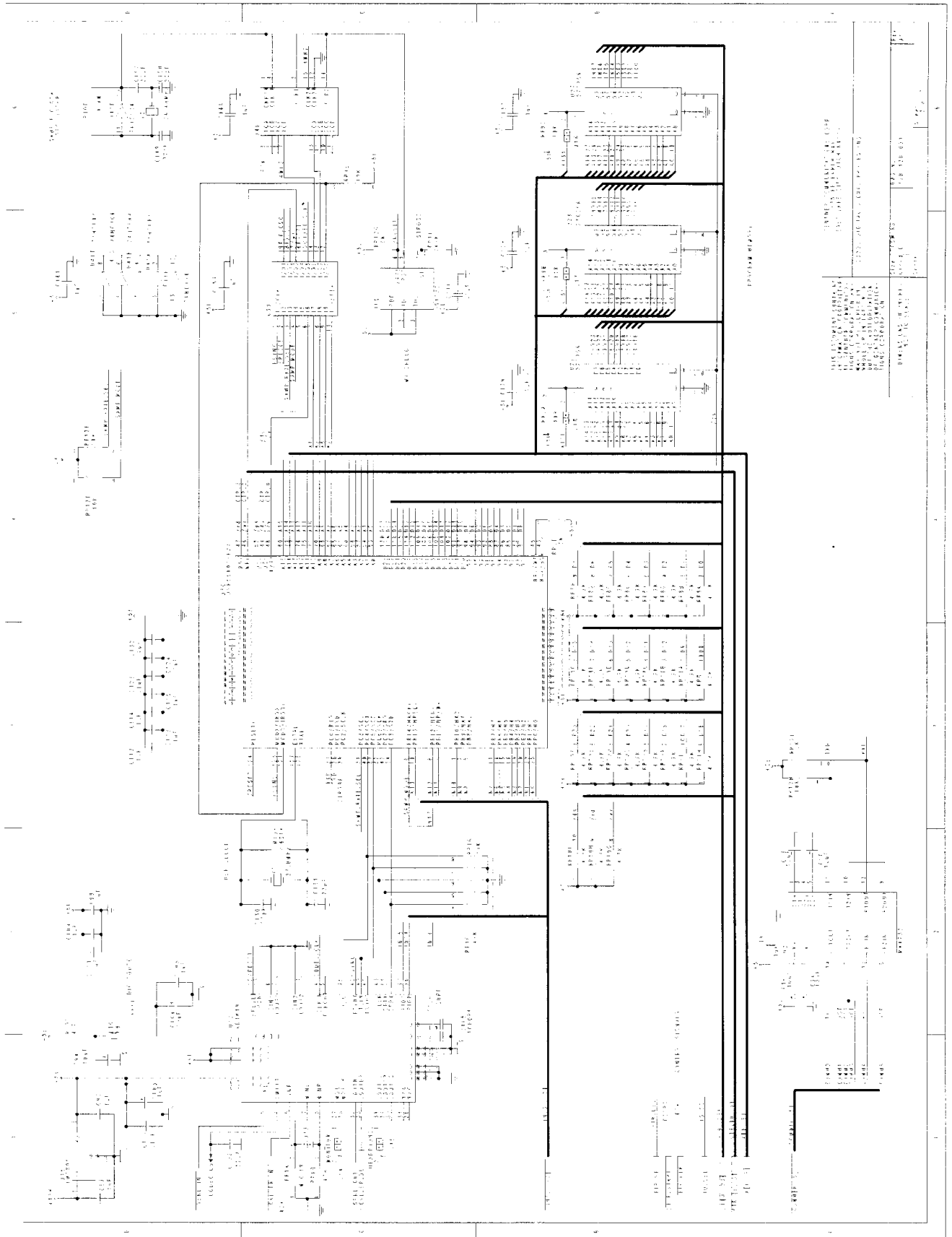

Appendix E:
Continued 

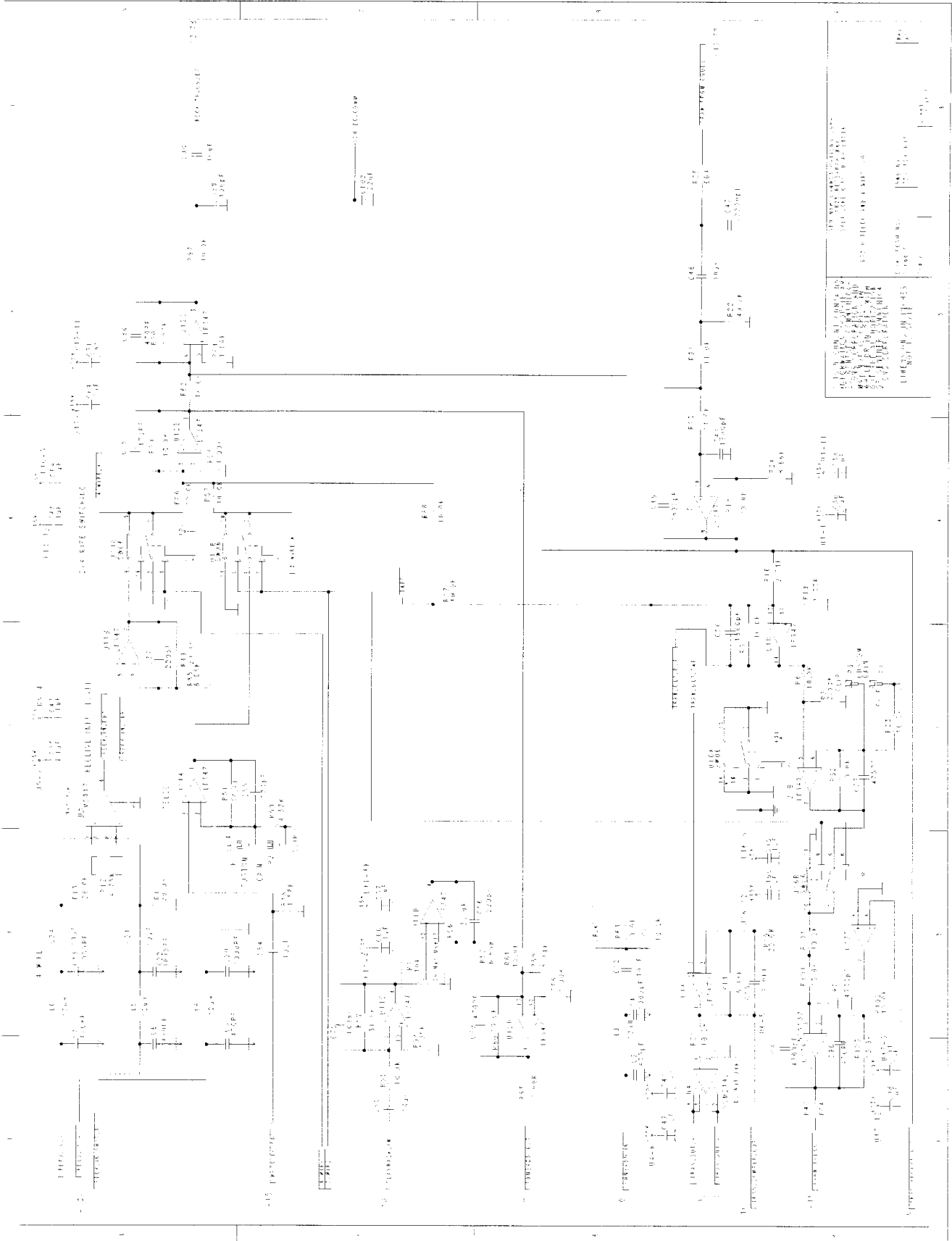

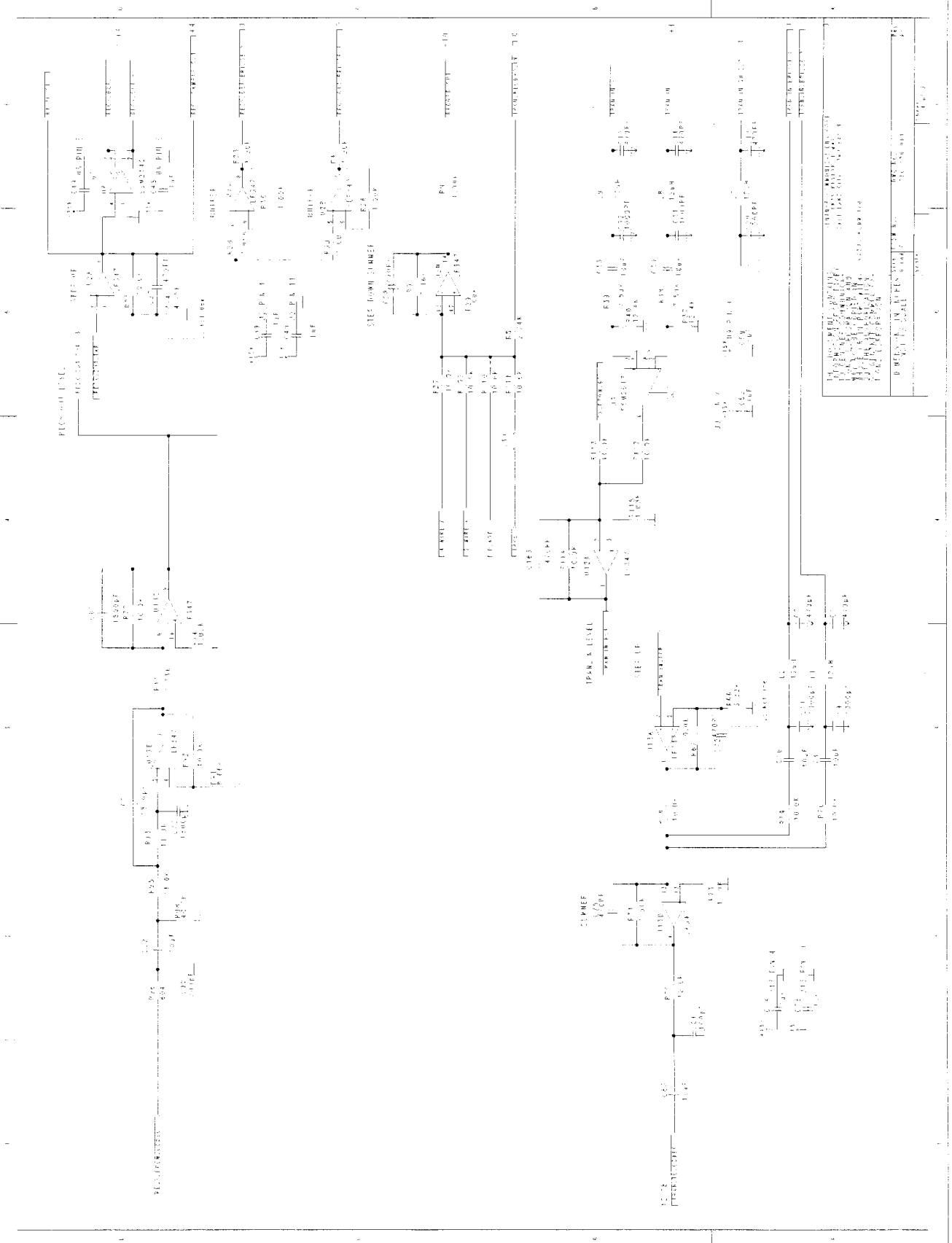

Appendix E:
Continued 

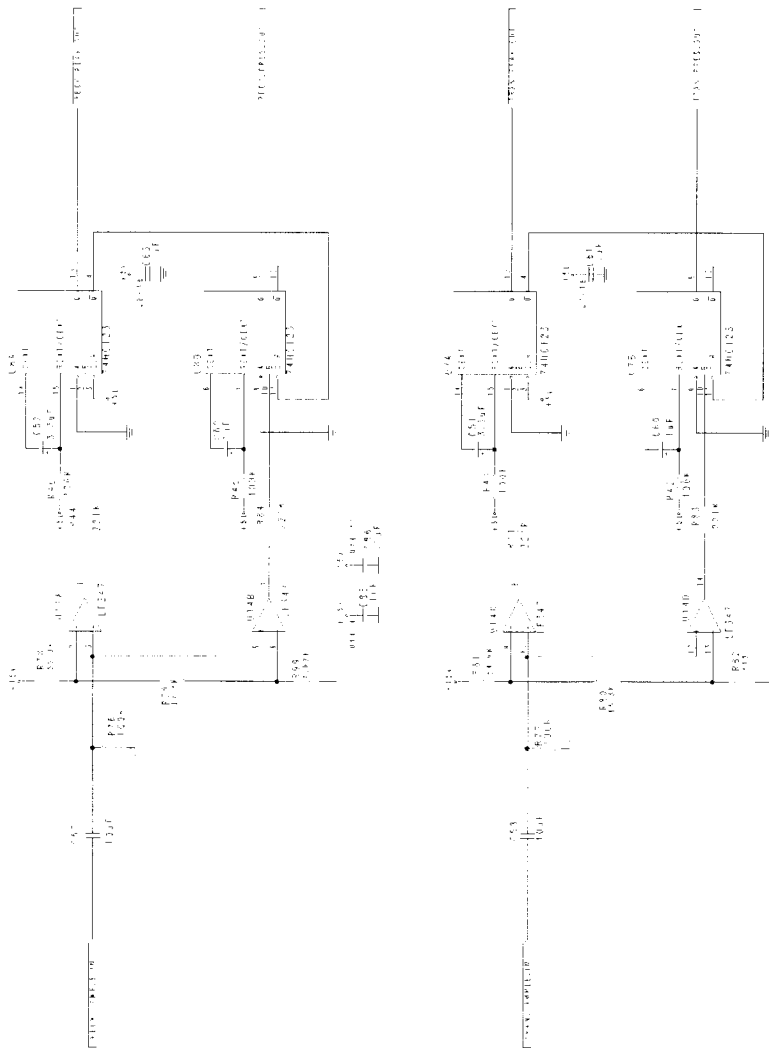

| | |
|--|--|
| <p>FOR TECHNICAL SERVICE CALL 800.945.7730 OR 801.975.7200 FOR SALES AND SERVICE CALL 800.945.7730 OR 801.975.7200</p> | <p>FOR TECHNICAL SERVICE CALL 800.945.7730 OR 801.975.7200 FOR SALES AND SERVICE CALL 800.945.7730 OR 801.975.7200</p> |
|--|--|

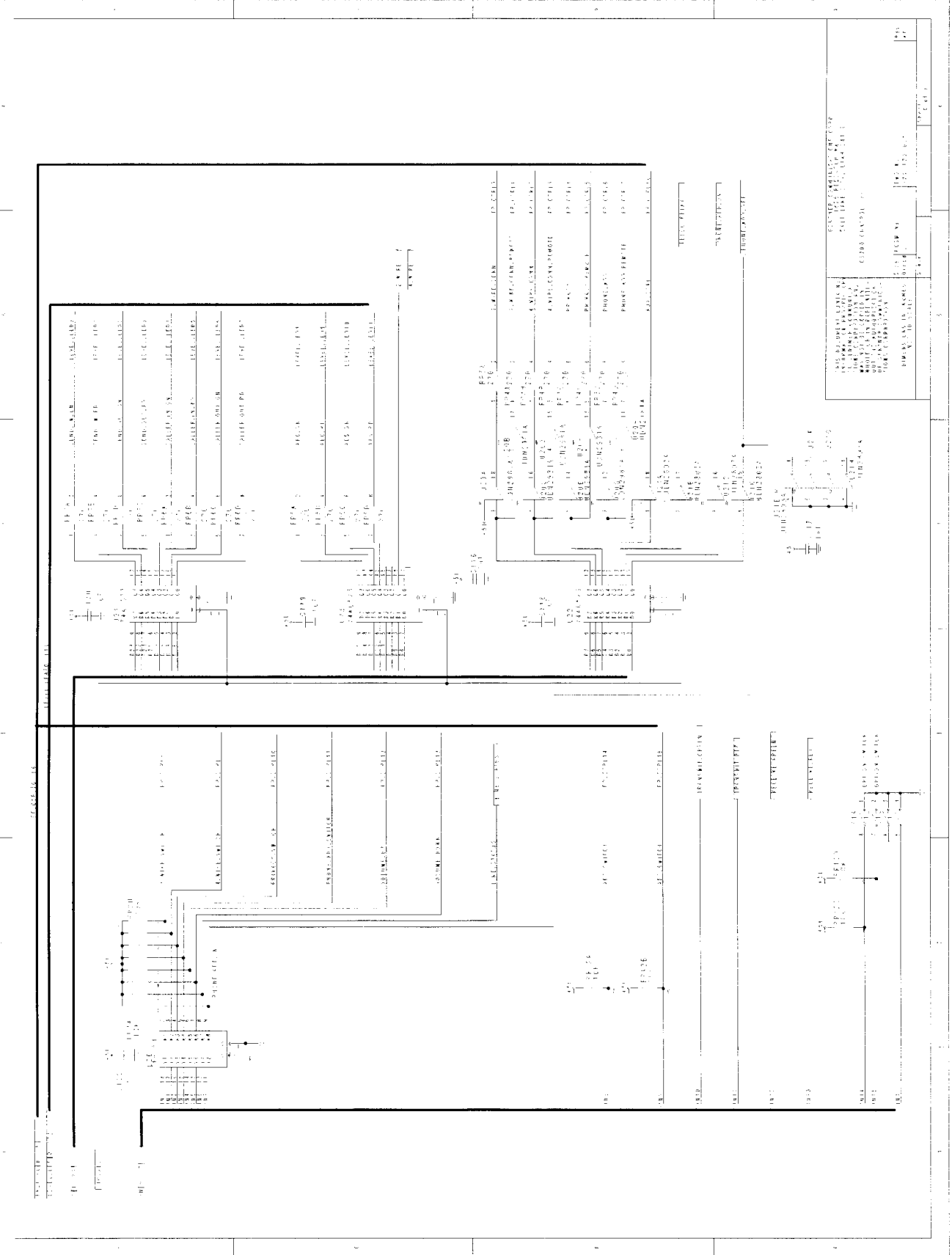

Appendix E:
Continued ≡

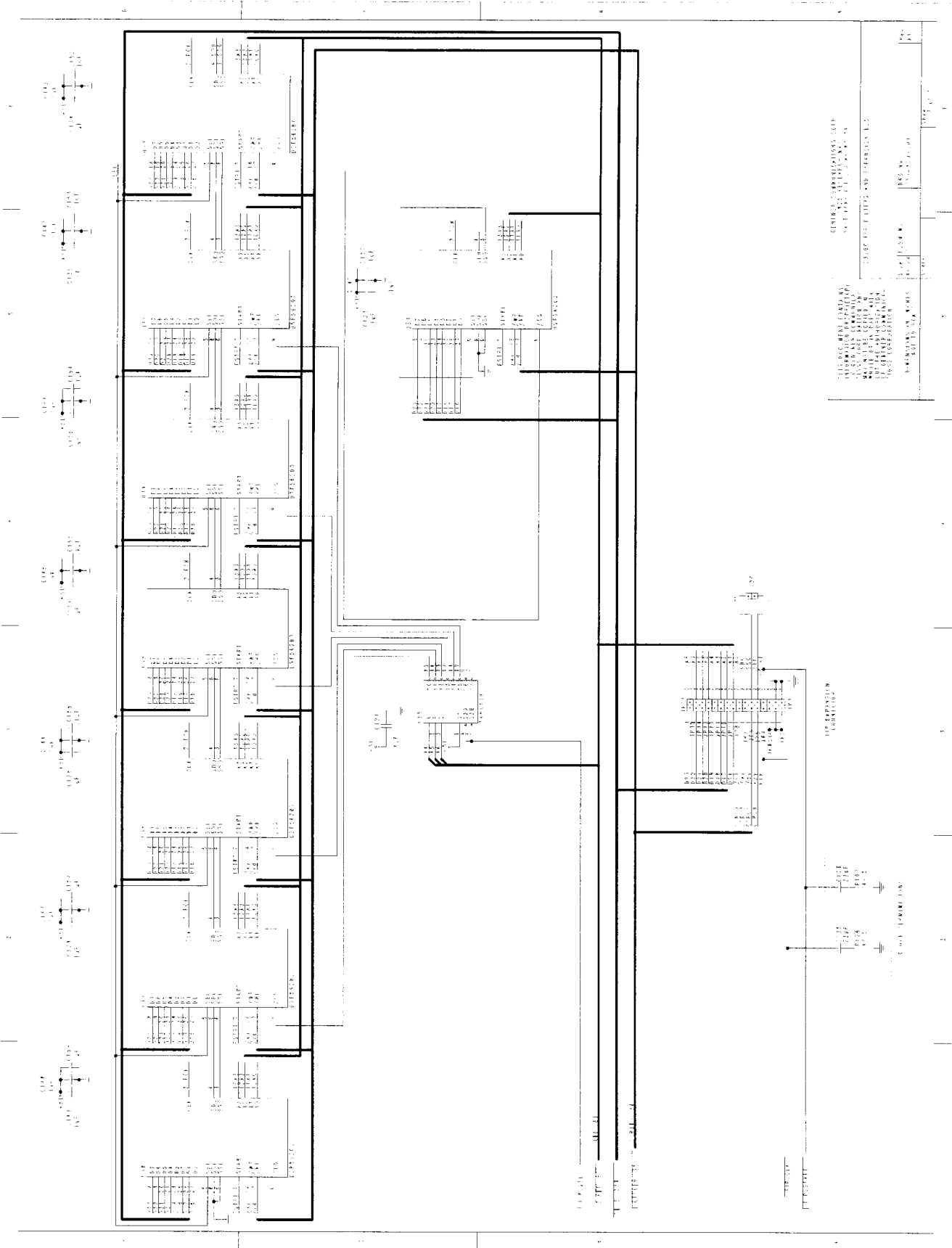

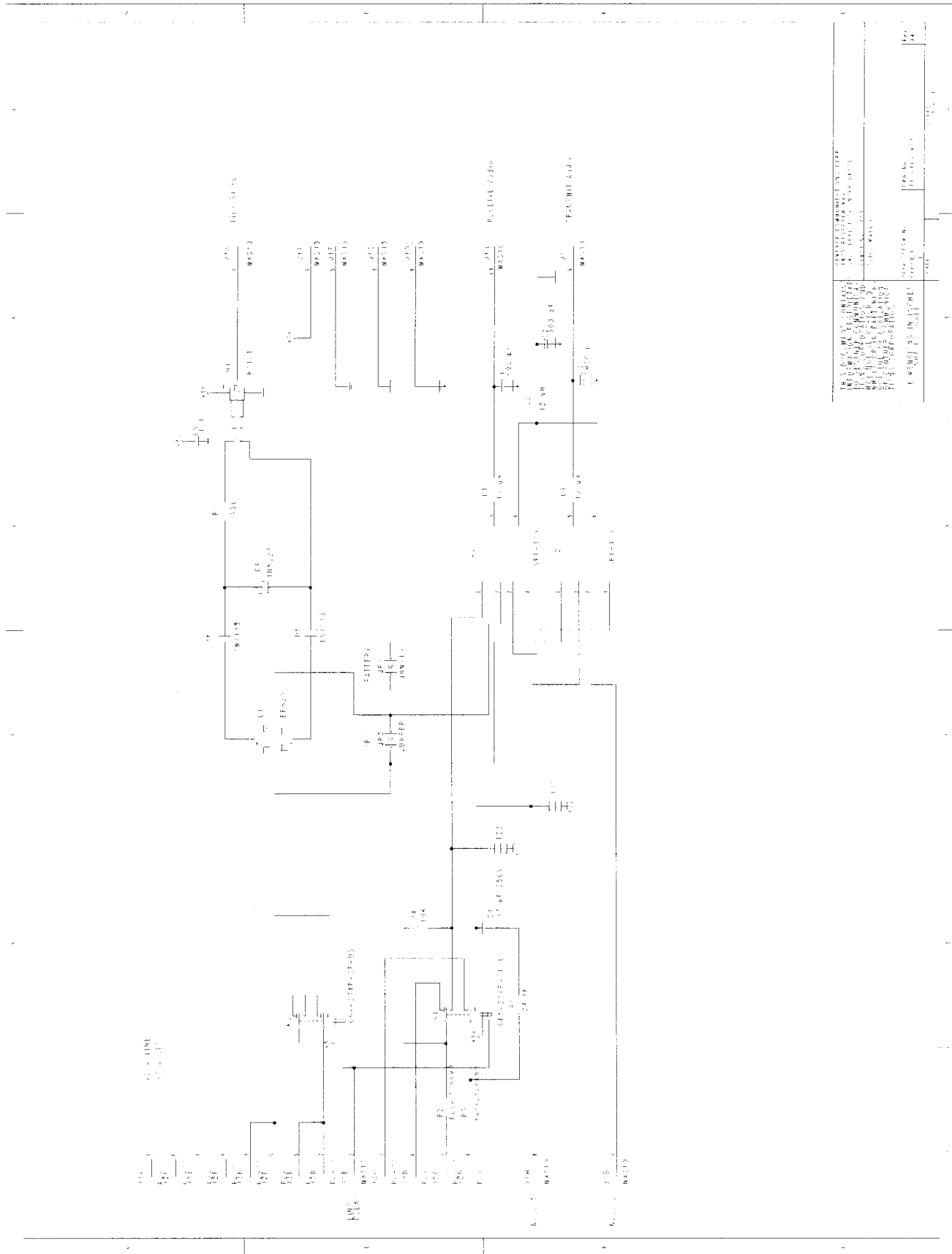

| | |
|--|--|
| <p>REVISIONS</p> <p>NO. DATE BY</p> <p>1 10/10/00 J. J. J.</p> <p>2 10/10/00 J. J. J.</p> <p>3 10/10/00 J. J. J.</p> <p>4 10/10/00 J. J. J.</p> <p>5 10/10/00 J. J. J.</p> <p>6 10/10/00 J. J. J.</p> <p>7 10/10/00 J. J. J.</p> <p>8 10/10/00 J. J. J.</p> <p>9 10/10/00 J. J. J.</p> <p>10 10/10/00 J. J. J.</p> | <p>APPROVED FOR CONSTRUCTION</p> <p>DATE: 10/10/00</p> <p>BY: J. J. J.</p> |
|--|--|